

FEH Medizintechnik

MEDIZINTECHNISCHE PRODUKTE



SÄGEBLÄTTER

MIT UNS SCHNEIDEN SIE GUT AB



Höchste Anforderungen

an Qualität und Präzision sind bei chirurgischen Instrumenten unabdingbar. So werden nur biokompatible Stähle mit hoher Säurebeständigkeit verwendet, die auch den Anforderungen der Sterilisation standhalten.

Wir verfügen über ein langjähriges Know-how in der Herstellung von chirurgischen Instrumenten und wissen worauf es ankommt:

- Präzision und Qualität
- Liefertreue und kurze Reaktionszeit
- Preis- und Leistungsverhältnis

Sonderanfertigungen werden in enger Zusammenarbeit mit dem Kunden entwickelt.

Unser Know-how

Die Anforderungen an chirurgische Instrumente sind hoch. Daher unterliegen unsere Produkte den besten Fertigungsprozessen und einer ständigen Qualitätskontrolle. Die Produktion wird durch ein Qualitätsmanagementsystem nach DIN ISO EN 13485: 2016 durchgeführt und überwacht.

Die Oberflächen der Sägeblätter werden vergütet, um bei der Anwendung am Knochen die Reibung, und damit durch Temperaturanstieg erzeugte Gewebnekrosen zu minimieren. Somit gibt es eine Reihe von Möglichkeiten das Operationsergebnis zu optimieren.



Maße und Bezeichnungen

- 1 SCHNITTBREITE**
Die Breite des Sägeblattes gemessen an der Außenkante der beiden äußeren Zähne.
- 2 NUTZBARE LÄNGE**
Maximale Eindringtiefe der Schneide
- 3 SCHNITTSTÄRKE**
Die Stärke des Sägeblattes gemessen an der Schneidekante.
- 4 MATERIALDICKE**
Die Dicke des Sägeblattes - überstehende Verzahnung nicht eingeschlossen.

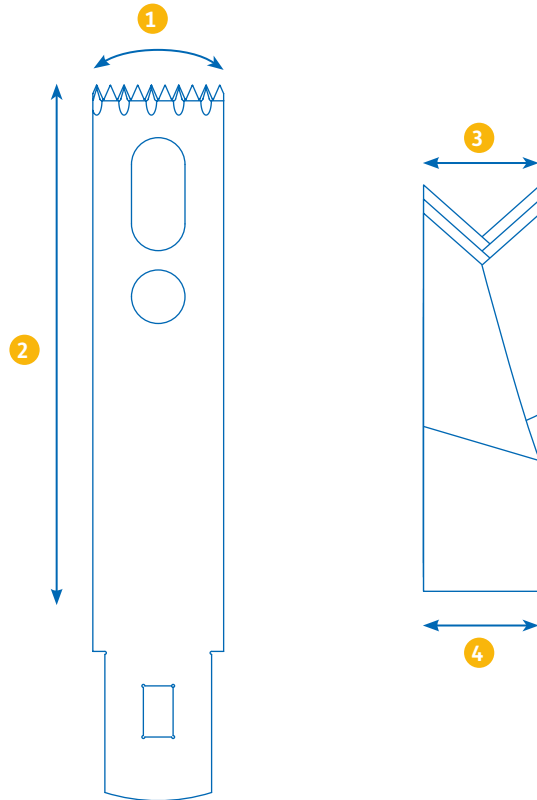

Bestellungsablauf

			SYNTHE [®]	AESCLAP [®]	AESCLAP [®] ACCULAN [®]
STERILE					
SCHNITTSTÄRKE	SCHNITTBREITE	NUTZBARE LÄNGE	ARTIKELNUMMER FEH UNSTERIL		
1,00 mm	22 mm	115 mm	G211090	G231090	G221090

Wählen Sie die verwendete Antriebsmaschine

Ihre Bestellnummer für **UNSTERILE** Sägeblätter: Artikelnummern für unsterile Sägeblätter enthalten kein „S“

			SYNTHE [®]	AESCLAP [®]	AESCLAP [®] ACCULAN [®]
STERILE					
SCHNITTSTÄRKE	SCHNITTBREITE	NUTZBARE LÄNGE	ARTIKELNUMMER FEH STERIL		
1,00 mm	22 mm	115 mm	G211090S	G231090S	G221090S

Ihre Bestellnummer für **STERILE** Sägeblätter: bitte das „S“ bei der Artikelnummer mit angeben

Sofort Verfügbare Sägeblätter:

AESCLAP[®], AESCLAP[®] ACCULAN[®], CONMED LINVATEC[®] 3M[®], DE SOUTER[®], HALL[®], STRYKER[®], STRYKER[®] SYSTEM S, STRYKER[®] PLUS, SYNTHES[®]

Weitere Ausführungen sind auf Anfrage lieferbar!



Kniesägeblätter

BITTE BEACHTEN SIE UNSEREN BESTELLABLAUF AUF SEITE 3 FÜR DIE UNSTERILEN SÄGEBLÄTTER

Unsere universell einsetzbaren Sägeblätter für alle Anwendungen der großen und kleinen Knochenchirurgie überzeugen durch

- geringe Eigenschwingung
- geringe Temperaturentwicklung
- hohe Schärfe
- hohe Schnittpräzision

Die Sägeblätter werden aus besonderem Edelstahl gefertigt, der auch bei hoher Belastung keinen Abrieb aufweist.

Alle Sägeblätter können wir Ihnen in steriler, wie auch in unsteriler Version anbieten.

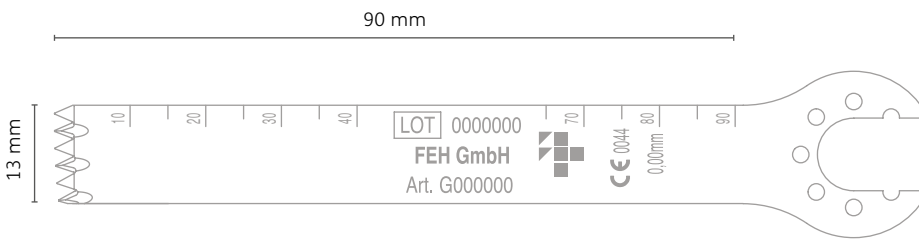
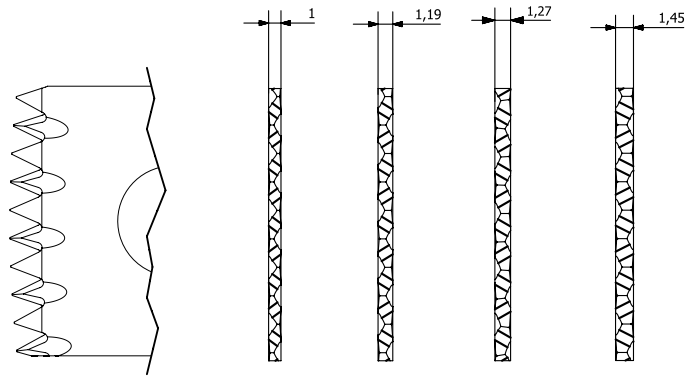

STERILE

--	--	--	--	--	--	--	--	--

SCHNITT-STÄRKE	SCHNITT-BREITE	NUTZBARE LÄNGE	ARTIKELNUMMER FEH								
0,89 mm	13 mm	90 mm	G211250S	G221250S	G251250S	G271250S	G241250S	G231250S	G261250S	G281250S	n.a.
1,00 mm	13 mm	90 mm	G211090S	G221090S	G224090S	G271090S	G241090S	G231090S	G261090S	G281090S	G251090S
1,19 mm	13 mm	90 mm	G212190S	G222190S	G224190S	G272190S	G242190S	G232190S	G262190S	G282190S	G252190S
1,27 mm	13 mm	90 mm	G212290S	G222290S	G224290S	G272290S	G242290S	G232290S	G262290S	G282290S	G252290S
1,37 mm	13 mm	90 mm	G211240S	G221240S	G251240S	G271240S	G241240S	G231240S	G261240S	G281240S	n.a.
1,45 mm	13 mm	90 mm	G212390S	G222390S	G224390S	G272390S	G242390S	G232390S	G262390S	G282390S	G252390S







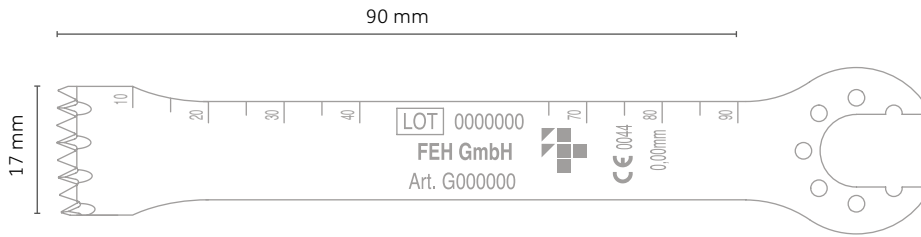

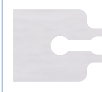

Kniesägeblätter

BITTE BEACHTEN SIE UNSEREN BESTELLABLAUF AUF SEITE 3 FÜR DIE UNSTERILEN SÄGEBLÄTTER

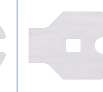

STERILE 

SYNTHES®	AESCULAP®	AESCULAP® ACCULAN®	STRYKER® SYSTEM S	STRYKER®	HALL®	CONMED LINVATEC® 3M®	DE SOUTTER®	STRYKER® PLUS
								

SCHNITT-STÄRKE	SCHNITT-BREITE	NUTZBARE LÄNGE	ARTIKELNUMMER FEH								
0,89 mm	17 mm	90 mm	G211450TS	G221450TS	G251450TS	G271450TS	G241450TS	G231450TS	G261450TS	G281450TS	n.a.
1,00 mm	17 mm	90 mm	G211400TS	G221400TS	G251400TS	G271400TS	G242400TS	G231400TS	G262400TS	G282400TS	n.a.
1,19 mm	17 mm	90 mm	G211410TS	G221410TS	G251410TS	G271410TS	G243410TS	G231410TS	G263410TS	G283410TS	n.a.
1,27 mm	17 mm	90 mm	G211420TS	G221420TS	G251420TS	G271420TS	G243420TS	G231420TS	G263420TS	G283420TS	n.a.
1,37 mm	17 mm	90 mm	G211440TS	G221440TS	G251440TS	G271440TS	G243440TS	G231440TS	G263440TS	G283440TS	n.a.
1,45 mm	17 mm	90 mm	G211430TS	G221430TS	G251430TS	G271430TS	G243430TS	G231430TS	G263430TS	G283430TS	n.a.
1,47 mm	17 mm	90 mm	G211460TS	G221460TS	G251460TS	G271460TS	G243460TS	G231460TS	G263460TS	G283460TS	n.a.

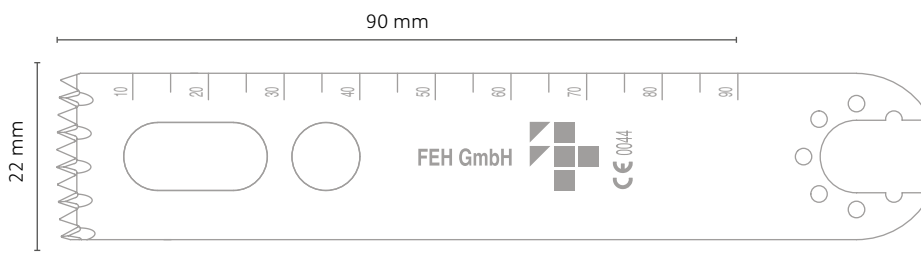

STERILE 

SYNTHES®	AESCULAP®	AESCULAP® ACCULAN®	STRYKER® SYSTEM S	STRYKER®	HALL®	CONMED LINVATEC® 3M®	DE SOUTTER®	STRYKER® PLUS
								

SCHNITT-STÄRKE	SCHNITT-BREITE	NUTZBARE LÄNGE	ARTIKELNUMMER FEH								
0,89 mm	22 mm	90 mm	G211150S	G221150S	G251150S	G271150S	G241150S	G231150S	n.a.	G281150S	n.a.
1,00 mm	22 mm	90 mm	G210990S	G220990S	G223090S	G270990S	G240990S	G230990S	G260990S	G280990S	G250990S
1,19 mm	22 mm	90 mm	G211190S	G221190S	G223190S	G271190S	G241190S	G231190S	G261190S	G281190S	G251190S
1,27 mm	22 mm	90 mm	G211290S	G221290S	G223290S	G271290S	G241290S	G231290S	G261290S	G281290S	G251290S
1,37 mm	22 mm	90 mm	G211390S	G221390S	G223390S	G271390S	G241390S	G231390S	G261390S	G281390S	G251390S
1,45 mm	22 mm	90 mm	G211140S	G221140S	G251140S	G271140S	G241140S	G231140S	n.a.	G281140S	n.a.
1,47 mm	22 mm	90 mm	G211160S	G222160S	G252160S	G272160S	G242160S	G232160S	n.a.	G281160S	n.a.



Kniesägeblätter

BITTE BEACHTEN SIE UNSEREN BESTELLABLAUF
AUF SEITE 3 FÜR DIE UNSTERILEN SÄGEBLÄTTER

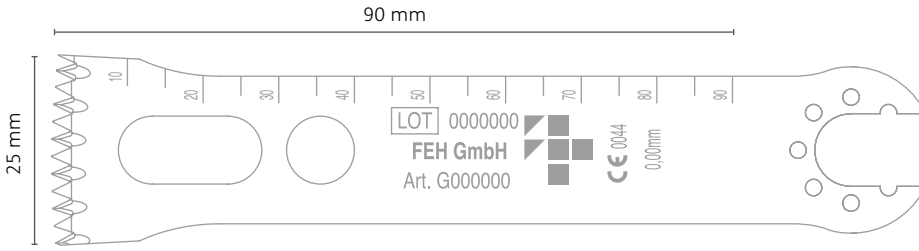

STERILE

SYNTHES®	AESCLAP®	AESCLAP® ACCULAN®	STRYKER® SYSTEM S	STRYKER®	HALL®	CONMED LINVATEC® 3M®	DE SOUTTER®	STRYKER® PLUS

SCHNITT- STÄRKE	SCHNITT- BREITE	NUTZBARE LÄNGE	ARTIKELNUMMER FEH								
0,89 mm	25 mm	90 mm	G21155TS	G22155TS	G25155TS	G27155TS	G24155TS	G23155TS	n.a.	G21155TS	n.a.
1,00 mm	25 mm	90 mm	G21150TS	G22150TS	G25150TS	G27150TS	G24150TS	G23150TS	n.a.	G21150TS	n.a.
1,19 mm	25 mm	90 mm	G21151TS	G22151TS	G25151TS	G27151TS	G24151TS	G23151TS	n.a.	G21151TS	n.a.
1,27 mm	25 mm	90 mm	G21152TS	G22152TS	G25152TS	G27152TS	G24152TS	G23152TS	n.a.	G21152TS	n.a.
1,37 mm	25 mm	90 mm	G21154TS	G22154TS	G25154TS	G27154TS	G24154TS	G23154TS	n.a.	G21154TS	n.a.
1,45 mm	25 mm	90 mm	G21153TS	G22153TS	G25153TS	G27153TS	G24153TS	G23153TS	n.a.	G21153TS	n.a.
1,47 mm	25 mm	90 mm	G21156TS	G22156TS	G25156TS	G27156TS	G24156TS	G23156TS	n.a.	G21156TS	n.a.

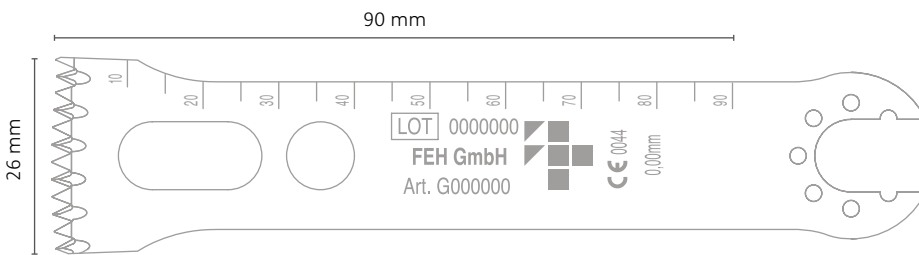

STERILE

SYNTHES®	AESCLAP®	AESCLAP® ACCULAN®	STRYKER® SYSTEM S	STRYKER®	HALL®	CONMED LINVATEC® 3M®	DE SOUTTER®	STRYKER® PLUS

SCHNITT- STÄRKE	SCHNITT- BREITE	NUTZBARE LÄNGE	ARTIKELNUMMER FEH								
0,89 mm	26 mm	90 mm	G21165TS	G22165TS	G25165TS	G27165TS	G24165TS	G23165TS	n.a.	G21165TS	n.a.
1,00 mm	26 mm	90 mm	G21160TS	G22160TS	G25160TS	G27160TS	G24160TS	G23160TS	n.a.	G21160TS	n.a.
1,19 mm	26 mm	90 mm	G21161TS	G22161TS	G25161TS	G27161TS	G24161TS	G23161TS	n.a.	G21161TS	n.a.
1,27 mm	26 mm	90 mm	G21162TS	G22162TS	G25162TS	G27162TS	G24162TS	G23162TS	n.a.	G21162TS	n.a.
1,37 mm	26 mm	90 mm	G21164TS	G22164TS	G25164TS	G27164TS	G24164TS	G23164TS	n.a.	G21164TS	n.a.
1,45 mm	26 mm	90 mm	G21163TS	G22163TS	G25163TS	G27163TS	G24163TS	G23163TS	n.a.	G21163TS	n.a.
1,47 mm	26 mm	90 mm	G21166TS	G22166TS	G25166TS	G27166TS	G24166TS	G23166TS	n.a.	G21166TS	n.a.



Kniesägeblätter Titan beschichtet

Titanbeschichtete Schnittflächen für besonders lange Lebensdauer.

Unsere universell einsetzbaren Sägeblätter für alle Anwendungen der großen und kleinen Knochenchirurgie überzeugen durch

- geringe Eigenschwingung
- geringe Temperaturentwicklung
- hohe Schärfe
- hohe Schnittpräzision

Die Sägeblätter werden aus besonderem Edelstahl gefertigt, der auch bei hoher Belastung keinen Abrieb aufweist.

Alle Sägeblätter können wir Ihnen in steriler, wie auch in unsteriler Version anbieten.

BITTE BEACHTEN SIE UNSEREN BESTELLABLAUF AUF SEITE 3 FÜR DIE UNSTERILEN SÄGEBLÄTTER

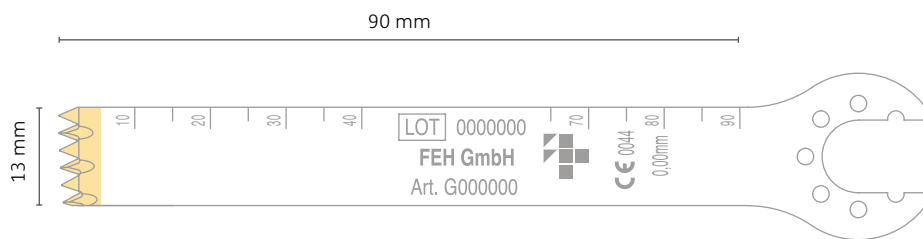
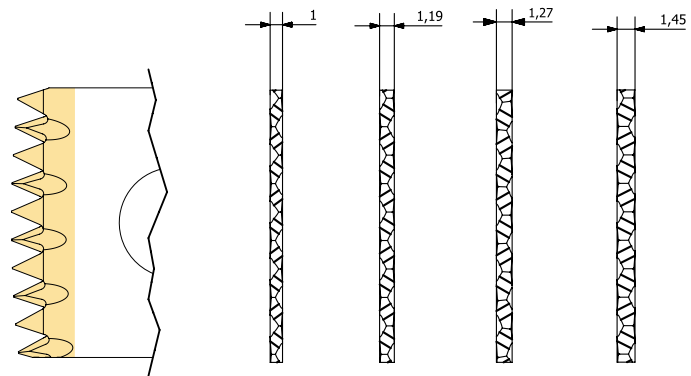

STERILE 

SYNTHES®	AESCULAP®	AESCULAP® ACCULAN®	STRYKER® SYSTEM S	STRYKER®	HALL®	CONMED LINVATEC® 3M®	DE SOUTTER®	STRYKER® PLUS
								



SCHNITT-STÄRKE	SCHNITT-BREITE	NUTZBARE LÄNGE	ARTIKELNUMMER FEH								
0,89 mm	13 mm	90 mm	G211250BS	G221250BS	G251250BS	G271250BS	G241250BS	G231250BS	G261250BS	G281250BS	n.a.
1,00 mm	13 mm	90 mm	G211090BS	G221090BS	G224090BS	G271090BS	G241090BS	G231090BS	G261090BS	G281090BS	G251090BS
1,19 mm	13 mm	90 mm	G212190BS	G222190BS	G224190BS	G272190BS	G242190BS	G232190BS	G262190BS	G282190BS	G252190BS
1,27 mm	13 mm	90 mm	G212290BS	G222290BS	G224290BS	G272290BS	G242290BS	G232290BS	G262290BS	G282290BS	G252290BS
1,37 mm	13 mm	90 mm	G211240BS	G221240BS	G251240BS	G271240BS	G241240BS	G231240BS	G261240BS	G281240BS	n.a.
1,45 mm	13 mm	90 mm	G212390BS	G222390BS	G224390BS	G272390BS	G242390BS	G232390BS	G262390BS	G282390BS	G252390BS

Kniesägeblätter

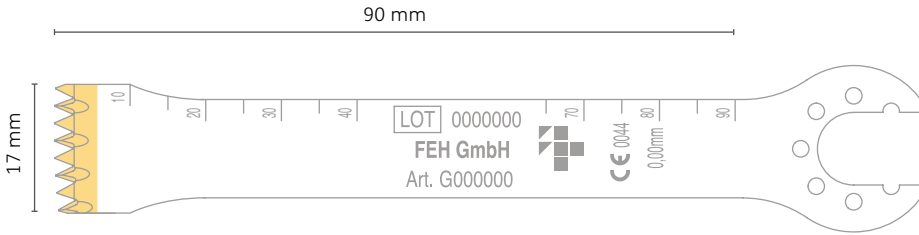
BITTE BEACHTEN SIE UNSEREN BESTELLBLAUF
AUF SEITE 3 FÜR DIE UNSTERILEN SÄGEBLÄTTER



STERILE 

SYNTHES®	AESCLAP®	AESCLAP® ACCULAN®	STRYKER® SYSTEM S	STRYKER®	HALL®	CONMED LINVATEC® 3M®	DE SOUTTER®	STRYKER® PLUS
								

SCHNITT- STÄRKE	SCHNITT- BREITE	NUTZBARE LÄNGE	ARTIKELNUMMER FEH								
0,89 mm	17 mm	90 mm	G211450TBS	G221450TBS	G251450TBS	G271450TBS	G241450TBS	G231450TBS	G261450TBS	G281450TBS	n.a.
1,00 mm	17 mm	90 mm	G211400TBS	G221400TBS	G251400TBS	G271400TBS	G242400TBS	G231400TBS	G262400TBS	G282400TBS	n.a.
1,19 mm	17 mm	90 mm	G211410TBS	G221410TBS	G251410TBS	G271410TBS	G243410TBS	G231410TBS	G263410TBS	G283410TBS	n.a.
1,27 mm	17 mm	90 mm	G211420TBS	G221420TBS	G251420TBS	G271420TBS	G243420TBS	G231420TBS	G263420TBS	G283420TBS	n.a.
1,37 mm	17 mm	90 mm	G211440TBS	G221440TBS	G251440TBS	G271440TBS	G243440TBS	G231440TBS	G263440TBS	G283440TBS	n.a.
1,45 mm	17 mm	90 mm	G211430TBS	G221430TBS	G251430TBS	G271430TBS	G243430TBS	G231430TBS	G263430TBS	G283430TBS	n.a.
1,47 mm	17 mm	90 mm	G211460TBS	G221460TBS	G251460TBS	G271460TBS	G243460TBS	G231460TBS	G263460TBS	G283460TBS	n.a.

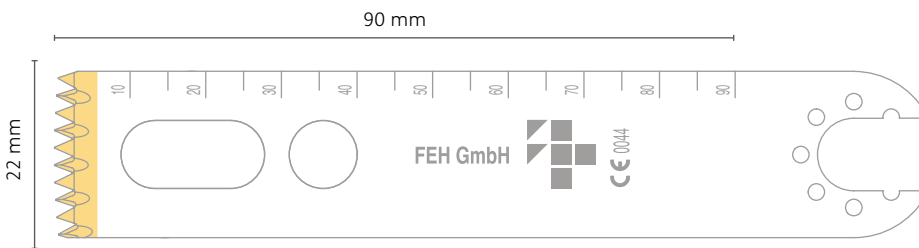

STERILE 

SYNTHES®	AESCLAP®	AESCLAP® ACCULAN®	STRYKER® SYSTEM S	STRYKER®	HALL®	CONMED LINVATEC® 3M®	DE SOUTTER®	STRYKER® PLUS
								

SCHNITT- STÄRKE	SCHNITT- BREITE	NUTZBARE LÄNGE	ARTIKELNUMMER FEH								
0,89 mm	22 mm	90 mm	G211150BS	G221150BS	G251150BS	G271150BS	G241150BS	G231150BS	n.a.	G281150BS	n.a.
1,00 mm	22 mm	90 mm	G210990BS	G220990BS	G223090BS	G270990BS	G240990BS	G230990BS	G260990BS	G280990BS	G250990BS
1,19 mm	22 mm	90 mm	G211190BS	G221190BS	G223190BS	G271190BS	G241190BS	G231190BS	G261190BS	G281190BS	G251190BS
1,27 mm	22 mm	90 mm	G211290BS	G221290BS	G223290BS	G271290BS	G241290BS	G231290BS	G261290BS	G281290BS	G251290BS
1,37 mm	22 mm	90 mm	G211390BS	G221390BS	G223390BS	G271390BS	G241390BS	G231390BS	G261390BS	G281390BS	G251390BS
1,45 mm	22 mm	90 mm	G211390BS	G221390BS	G223390BS	G271390BS	G241390BS	G231390BS	G261390BS	G281390BS	G251390BS
1,47 mm	22 mm	90 mm	G211160BS	G222160BS	G252160BS	G272160S	G242160SB	G232160BS	n.a.	G281160BS	n.a.



Kniesägeblätter

BITTE BEACHTEN SIE UNSEREN BESTELLABLAUF AUF SEITE 3 FÜR DIE UNSTERILEN SÄGEBLÄTTER

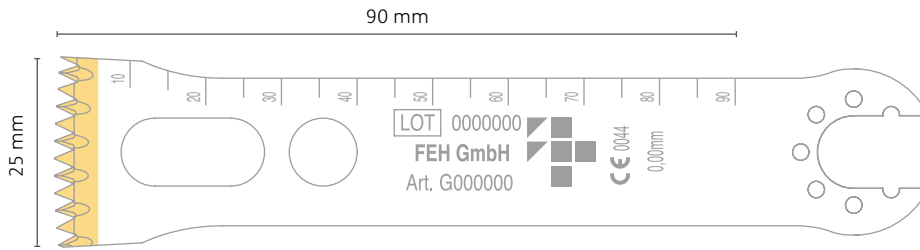

STERILE 

SYNTHE[®]	AESCLAP[®]	AESCLAP[®] ACCULAN[®]	STRYKER[®] SYSTEM S	STRYKER[®]	HALL[®]	CONMED LINVATEC[®] 3M[®]	DE SOUTTER[®]	STRYKER[®] PLUS
								

SCHNITT-STÄRKE	SCHNITT-BREITE	NUTZBARE LÄNGE	ARTIKELNUMMER FEH								
0,89 mm	25 mm	90 mm	G21155TBS	G22155TBS	G25155TBS	G27155TBS	G24155TBS	G23155TBS	n.a.	G21155TBS	n.a.
1,00 mm	25 mm	90 mm	G21150TBS	G22150TBS	G25150TBS	G27150TBS	G24150TBS	G23150TBS	n.a.	G21150TBS	n.a.
1,19 mm	25 mm	90 mm	G21151TBS	G22151TBS	G25151TBS	G27151TBS	G24151TBS	G23151TBS	n.a.	G21151TBS	n.a.
1,27 mm	25 mm	90 mm	G21152TBS	G22152TBS	G25152TBS	G27152TBS	G24152TBS	G23152TBS	n.a.	G21152TBS	n.a.
1,37 mm	25 mm	90 mm	G21154TBS	G22154TBS	G25154TBS	G27154TBS	G24154TBS	G23154TBS	n.a.	G21154TBS	n.a.
1,45 mm	25 mm	90 mm	G21153TBS	G22153TBS	G25153TBS	G27153TBS	G24153TBS	G23153TBS	n.a.	G21153TBS	n.a.
1,47 mm	25 mm	90 mm	G21156TBS	G22156TBS	G25156TBS	G27156TBS	G24156TBS	G23156TBS	n.a.	G21156TBS	n.a.

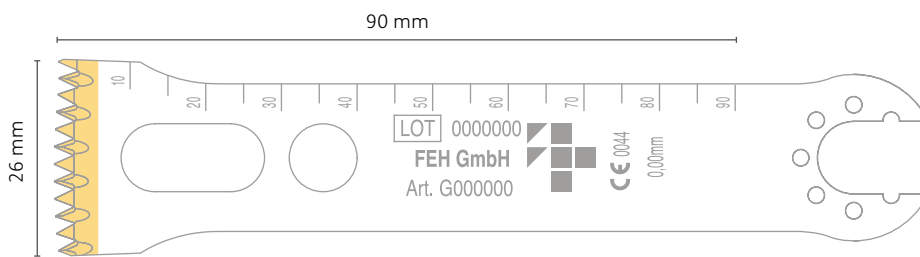

STERILE 

SYNTHE[®]	AESCLAP[®]	AESCLAP[®] ACCULAN[®]	STRYKER[®] SYSTEM S	STRYKER[®]	HALL[®]	CONMED LINVATEC[®] 3M[®]	DE SOUTTER[®]	STRYKER[®] PLUS
								

SCHNITT-STÄRKE	SCHNITT-BREITE	NUTZBARE LÄNGE	ARTIKELNUMMER FEH								
0,89 mm	26 mm	90 mm	G21165TBS	G22165TBS	G25165TBS	G27165TBS	G24165TBS	G23165TBS	n.a.	G21165TBS	n.a.
1,00 mm	26 mm	90 mm	G21160TBS	G22160TBS	G25160TBS	G27160TBS	G24160TBS	G23160TBS	n.a.	G21160TBS	n.a.
1,19 mm	26 mm	90 mm	G21161TBS	G22161TBS	G25161TBS	G27161TBS	G24161TBS	G23161TBS	n.a.	G21161TBS	n.a.
1,27 mm	26 mm	90 mm	G21162TBS	G22162TBS	G25162TBS	G27162TBS	G24162TBS	G23162TBS	n.a.	G21162TBS	n.a.
1,37 mm	26 mm	90 mm	G21164TBS	G22164TBS	G25164TBS	G27164TBS	G24164TBS	G23164TBS	n.a.	G21164TBS	n.a.
1,45 mm	26 mm	90 mm	G21163TBS	G22163TBS	G25163TBS	G27163TBS	G24163TBS	G23163TBS	n.a.	G21163TBS	n.a.
1,47 mm	26 mm	90 mm	G21166TBS	G22166TBS	G25166TBS	G27166TBS	G24166TBS	G23166TBS	n.a.	G21166TSB	n.a.

STRYKER®

Sägeblätter für Sagittalsägeaufsatz

BITTE BEACHTEN SIE UNSEREN BESTELLABLAUF AUF SEITE 3 FÜR DIE UNSTERILEN SÄGEBLÄTTER

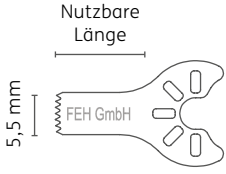

STERILE 

STRYKER®

BLATTDICKE/ SCHNITTSTÄRKE	SCHNITT- BREITE	NUTZBARE LÄNGE	ARTIKEL-NR. ORIGINAL	ARTIKEL-NR. FEH
0,4 / 0,6 mm	5,5 mm	11,5 mm	KM3-410	G134104S
0,4 / 0,6 mm	5,5 mm	18 mm	KM3-412	G1316104S

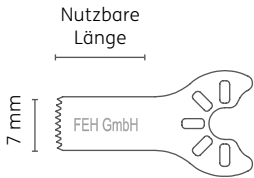
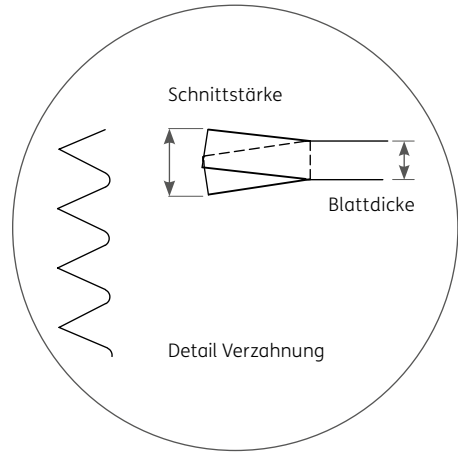

STERILE 

STRYKER®

BLATTDICKE/ SCHNITTSTÄRKE	SCHNITT- BREITE	NUTZBARE LÄNGE	ARTIKEL-NR. ORIGINAL	ARTIKEL-NR. FEH
0,5 / 0,7 mm	7 mm	15 mm	KM33-103	G1310158S
0,5 / 0,6 mm	7 mm	18,5 mm	KM33-114	G1316158S
0,5 / 0,7 mm	7 mm	29,5 mm	KM33-115	G1342158S

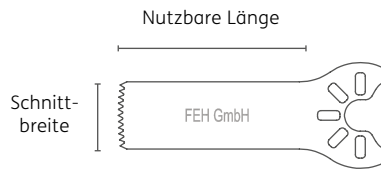

STERILE 

STRYKER®

BLATTDICKE/ SCHNITTSTÄRKE	SCHNITT- BREITE	NUTZBARE LÄNGE	ARTIKEL-NR. ORIGINAL	ARTIKEL-NR. FEH
0,4 / 0,6 mm	9 mm	25 mm	KM3-511	G1317119S
0,4 / 0,6 mm	9,5 mm	11,5 mm	KM3-411	G134254S
0,4 / 0,6 mm	9,8 mm	25 mm	KM3-111	G1330264S
0,4 / 0,6 mm	9,8 mm	31 mm	KM3-125	G1344264S
0,5 / 0,7 mm	9,8 mm	25 mm	KM33-111	G1330268S
0,5 / 0,7 mm	9,8 mm	18,5 mm	KM33-105	G1317268S
0,5 / 0,6 mm	10 mm	31 mm	KM33-125	G1344247S

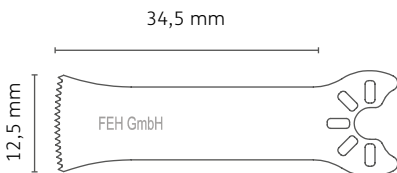

STERILE 

STRYKER®

BLATTDICKE/ SCHNITTSTÄRKE	SCHNITT- BREITE	NUTZBARE LÄNGE	ARTIKEL-NR. ORIGINAL	ARTIKEL-NR. FEH
0,5 / 0,7 mm	12,5 mm	34,5 mm	KM33-206	G1346358AS

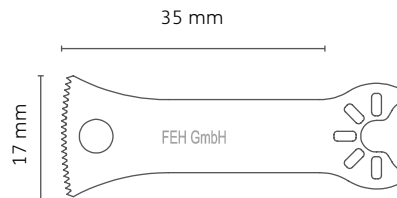

STERILE 

STRYKER®

BLATTDICKE/ SCHNITTSTÄRKE	SCHNITT- BREITE	NUTZBARE LÄNGE	ARTIKEL-NR. ORIGINAL	ARTIKEL-NR. FEH
0,5 mm	17 mm	35 mm	KM33-104	G1346477AS



HALL® SAGITTAL

Sägeblätter für Sagittalsägeaufsatz

BITTE BEACHTEN SIE UNSEREN BESTELLABLAUF AUF SEITE 3 FÜR DIE UNSTERILEN SÄGEBLÄTTER

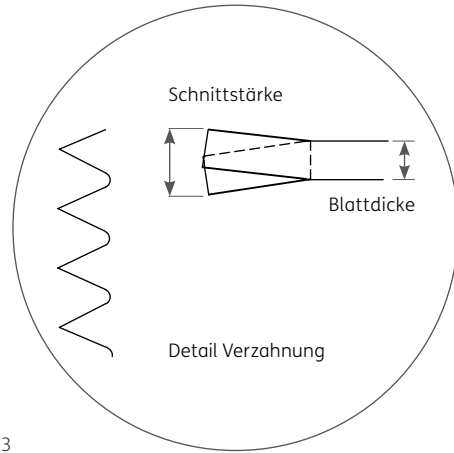
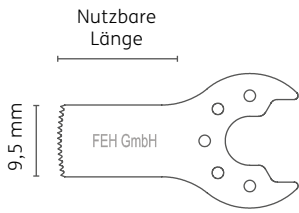

STERILE 

HALL®

BLATTDICKE/ SCHNITTSTÄRKE	SCHNITT- BREITE	NUTZBARE LÄNGE	ARTIKEL-NR. ORIGINAL	ARTIKEL-NR. FEH
0,4 / 0,6 mm	9,5 mm	16 mm	KM-3104	G1612254S
0,4 / 0,6 mm	9,5 mm	18,5 mm	-	G1617254S
0,4 / 0,6 mm	9,5 mm	25,5 mm	KM-3101	G1632254S

> ersetzt G142413

> ersetzt G162790

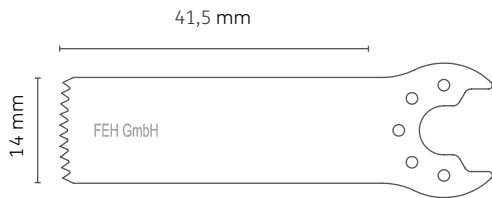

STERILE 

HALL®

BLATTDICKE/ SCHNITTSTÄRKE	SCHNITT- BREITE	NUTZBARE LÄNGE	ARTIKEL-NR. ORIGINAL	ARTIKEL-NR. FEH
0,4 / 0,6 mm	14 mm	41,5 mm	KM-3100C	G1652404S

HALL® OSZILLIEREND

Sägeblätter für oszillierenden Sägeaufsatz

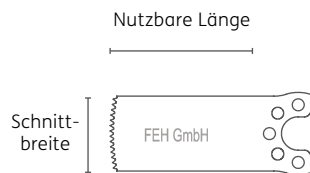
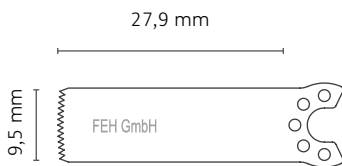

STERILE 

HALL®

BLATTDICKE/ SCHNITTSTÄRKE	SCHNITT- BREITE	NUTZBARE LÄNGE	ARTIKEL-NR. ORIGINAL	ARTIKEL-NR. FEH
0,4 / 0,6 mm	9,5 mm	27,9 mm	KM-3004	G1739254S

STERILE 

HALL®

BLATTDICKE/ SCHNITTSTÄRKE	SCHNITT- BREITE	NUTZBARE LÄNGE	ARTIKEL-NR. ORIGINAL	ARTIKEL-NR. FEH
0,4 / 0,6 mm	9,5 mm	18,5 mm	KM-3005	G1717254S
0,4 / 0,6 mm	10 mm	31 mm	KM-3002	G1744274S



SYNTHES® COLIBRI

Sägeblätter für oszillierenden Sägeaufsatz

BITTE BEACHTEN SIE UNSEREN BESTELLABLAUF
AUF SEITE 3 FÜR DIE UNSTERILEN SÄGEBLÄTTER

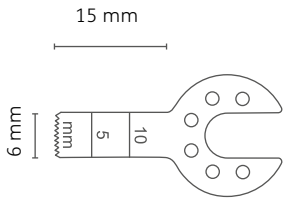

STERILE

SYNTHES®
COLIBRI

BLATTDICKE/ SCHNITTSTÄRKE	SCHNITT- BREITE	NUTZBARE LÄNGE	ARTIKEL-NR. ORIGINAL	ARTIKEL-NR. FEH
0,30/0,40 mm	6 mm	15 mm	532.041S	G1810111S

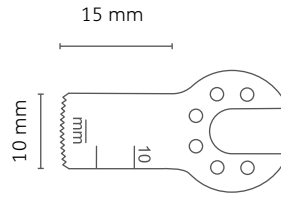

STERILE

SYNTHES®
COLIBRI

BLATTDICKE/ SCHNITTSTÄRKE	SCHNITT- BREITE	NUTZBARE LÄNGE	ARTIKEL-NR. ORIGINAL	ARTIKEL-NR. FEH
0,30/0,40 mm	10 mm	15 mm	532.042S	G1810271S

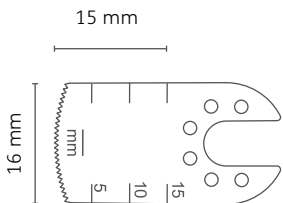

STERILE

SYNTHES®
COLIBRI

BLATTDICKE/ SCHNITTSTÄRKE	SCHNITT- BREITE	NUTZBARE LÄNGE	ARTIKEL-NR. ORIGINAL	ARTIKEL-NR. FEH
0,30/0,40 mm	16 mm	15 mm	532.043S	G1810461S

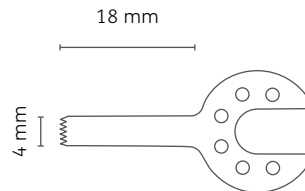

STERILE

SYNTHES®
COLIBRI

BLATTDICKE/ SCHNITTSTÄRKE	SCHNITT- BREITE	NUTZBARE LÄNGE	ARTIKEL-NR. ORIGINAL	ARTIKEL-NR. FEH
0,30/0,40 mm	4 mm	18 mm	532.044S	G181651S

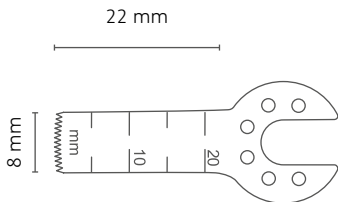

STERILE

SYNTHES®
COLIBRI

BLATTDICKE/ SCHNITTSTÄRKE	SCHNITT- BREITE	NUTZBARE LÄNGE	ARTIKEL-NR. ORIGINAL	ARTIKEL-NR. FEH
0,30/0,40 mm	8 mm	22 mm	532.045S	G1824201S

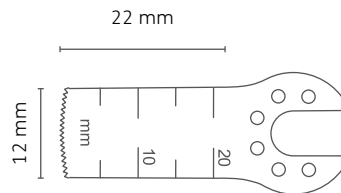

STERILE

SYNTHES®
COLIBRI

BLATTDICKE/ SCHNITTSTÄRKE	SCHNITT- BREITE	NUTZBARE LÄNGE	ARTIKEL-NR. ORIGINAL	ARTIKEL-NR. FEH
0,30/0,40 mm	12 mm	22 mm	532.046S	G1824341S

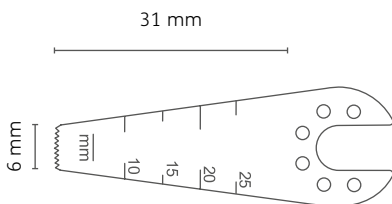

STERILE

SYNTHES®
COLIBRI

BLATTDICKE/ SCHNITTSTÄRKE	SCHNITT- BREITE	NUTZBARE LÄNGE	ARTIKEL-NR. ORIGINAL	ARTIKEL-NR. FEH
0,30/0,40 mm	6 mm	31 mm	532.047S	G1844111VS

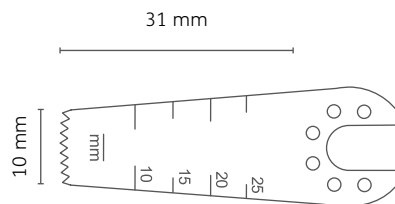

STERILE

SYNTHES®
COLIBRI

BLATTDICKE/ SCHNITTSTÄRKE	SCHNITT- BREITE	NUTZBARE LÄNGE	ARTIKEL-NR. ORIGINAL	ARTIKEL-NR. FEH
0,30/0,40 mm	10 mm	31 mm	532.048S	G1844271VS



SYNTHES® COLIBRI

Sägeblätter für oszillierenden Sägeaufsatz

BITTE BEACHTEN SIE UNSEREN BESTELLABLAUF AUF SEITE 3 FÜR DIE UNSTERILEN SÄGEBLÄTTER

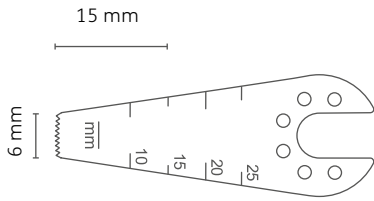

STERILE 

SYNTHES®
COLIBRI

BLATTDICKE/ SCHNITTSTÄRKE	SCHNITT- BREITE	NUTZBARE LÄNGE	ARTIKEL-NR. ORIGINAL	ARTIKEL-NR. FEH
0,30/0,60 mm	6 mm	27 mm	532.061S	G18361120VS

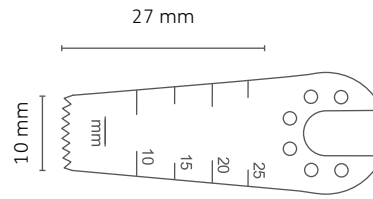

STERILE 

SYNTHES®
COLIBRI

BLATTDICKE/ SCHNITTSTÄRKE	SCHNITT- BREITE	NUTZBARE LÄNGE	ARTIKEL-NR. ORIGINAL	ARTIKEL-NR. FEH
0,30/0,60 mm	10 mm	27 mm	532.062S	G18362720VS

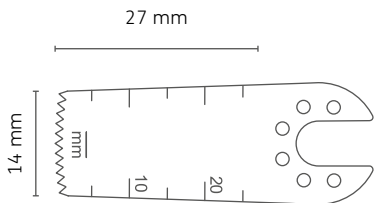

STERILE 

SYNTHES®
COLIBRI

BLATTDICKE/ SCHNITTSTÄRKE	SCHNITT- BREITE	NUTZBARE LÄNGE	ARTIKEL-NR. ORIGINAL	ARTIKEL-NR. FEH
0,30/0,60 mm	14 mm	27 mm	532.063S	G18364020S

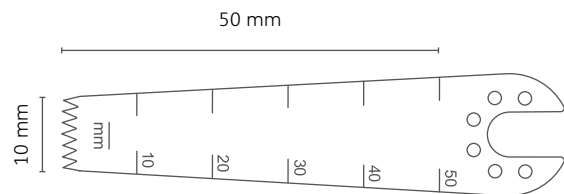

STERILE 

SYNTHES®
COLIBRI

BLATTDICKE/ SCHNITTSTÄRKE	SCHNITT- BREITE	NUTZBARE LÄNGE	ARTIKEL-NR. ORIGINAL	ARTIKEL-NR. FEH
0,30/0,60 mm	10 mm	50 mm	532.064S	G18632720VS

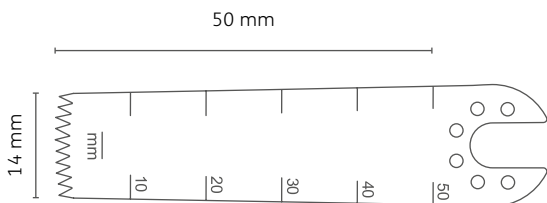

STERILE 

SYNTHES®
COLIBRI

BLATTDICKE/ SCHNITTSTÄRKE	SCHNITT- BREITE	NUTZBARE LÄNGE	ARTIKEL-NR. ORIGINAL	ARTIKEL-NR. FEH
0,30/0,60 mm	14 mm	50 mm	532.065S	G18634020S

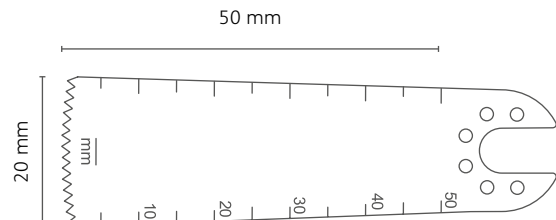

STERILE 

SYNTHES®
COLIBRI

BLATTDICKE/ SCHNITTSTÄRKE	SCHNITT- BREITE	NUTZBARE LÄNGE	ARTIKEL-NR. ORIGINAL	ARTIKEL-NR. FEH
0,30/0,60 mm	20 mm	50 mm	532.066S	G18635620AS

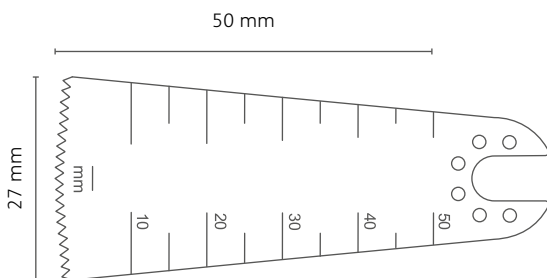

STERILE 

SYNTHES®
COLIBRI

BLATTDICKE/ SCHNITTSTÄRKE	SCHNITT- BREITE	NUTZBARE LÄNGE	ARTIKEL-NR. ORIGINAL	ARTIKEL-NR. FEH
0,30/0,60 mm	27 mm	50 mm	532.067S	G18636720AS



SYNTHES®

Sägeblätter für Sagittalsägeaufsatz

BITTE BEACHTEN SIE UNSEREN BESTELLABLAUF AUF SEITE 3 FÜR DIE UNSTERILEN SÄGEBLÄTTER

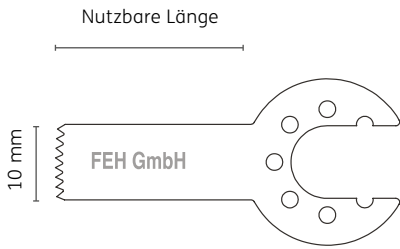

STERILE				SYNTHES®
SCHNITT-STÄRKE	SCHNITT-BREITE	NUTZBARE LÄNGE	ARTIKEL-NR. ORIGINAL	ARTIKEL-NR. FEH
0,6 mm	10 mm	25 mm	519.103S	G111302710S
0,6 mm	10 mm	49 mm	519.104S	G11632710S

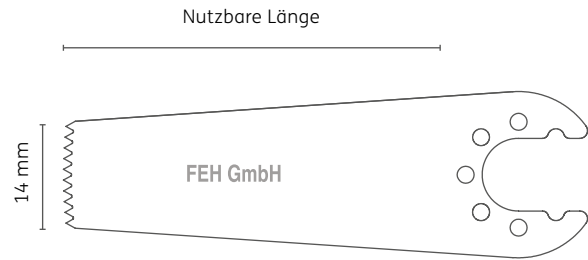

STERILE				SYNTHES®
SCHNITT-STÄRKE	SCHNITT-BREITE	NUTZBARE LÄNGE	ARTIKEL-NR. ORIGINAL	ARTIKEL-NR. FEH
0,6 mm	14 mm	25 mm	519.250S	G11304010S
0,6 mm	14 mm	49 mm	519.150S	G11634010S

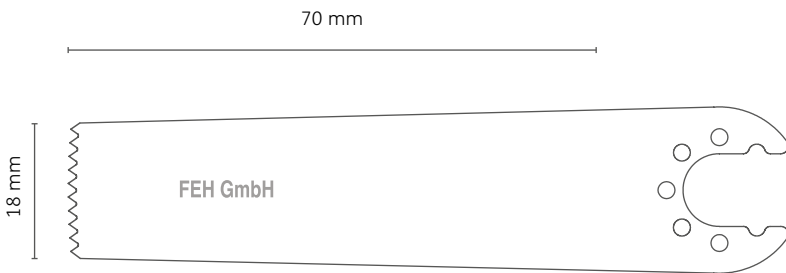

STERILE				SYNTHES®
SCHNITT-STÄRKE	SCHNITT-BREITE	NUTZBARE LÄNGE	ART.-NR. ORIGINAL	ART.-NR. FEH
1 mm	18 mm	69 mm	519.106S	G11725118S
1,2 mm	18 mm	69 mm	519.113S	G11725119S

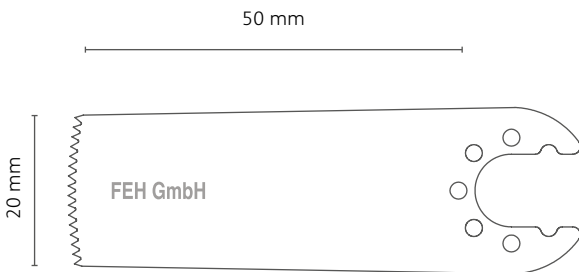
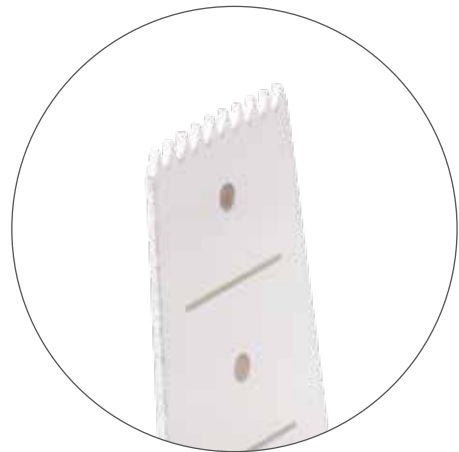

STERILE				SYNTHES®
SCHNITT-STÄRKE	SCHNITT-BREITE	NUTZBARE LÄNGE	ARTIKEL-NR. ORIGINAL	ARTIKEL-NR. FEH
0,6 mm	20 mm	49 mm	519.105S	G11635610S

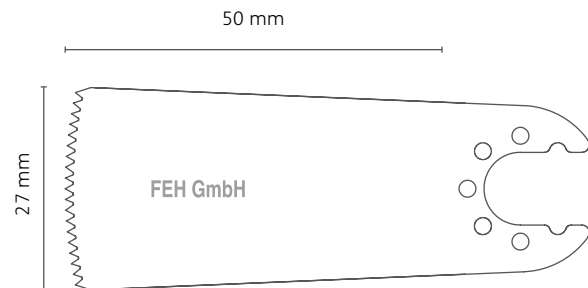

STERILE				SYNTHES®
SCHNITT-STÄRKE	SCHNITT-BREITE	NUTZBARE LÄNGE	ARTIKEL-NR. ORIGINAL	ARTIKEL-NR. FEH
0,6 mm	27 mm	49 mm	519.100S	G11636710AS



AESFULAP® ACCULAN®

Sägeblätter für Sagittalsägeaufsatz

BITTE BEACHTEN SIE UNSEREN BESTELLABLAUF
AUF SEITE 3 FÜR DIE UNSTERILEN SÄGEBLÄTTER

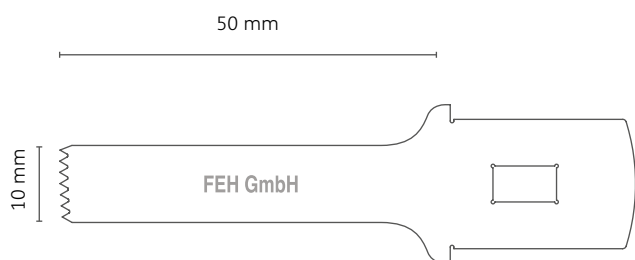

STERILE 

AESFULAP®
ACCULAN®

BLATTDICKE/ SCHNITTSTÄRKE	SCHNITT- BREITE	NUTZBARE LÄNGE	ARTIKEL-NR. ORIGINAL	ARTIKEL-NR. FEH
0,5 / 0,8 mm	10 mm	50 mm	GC215R	G1263279S

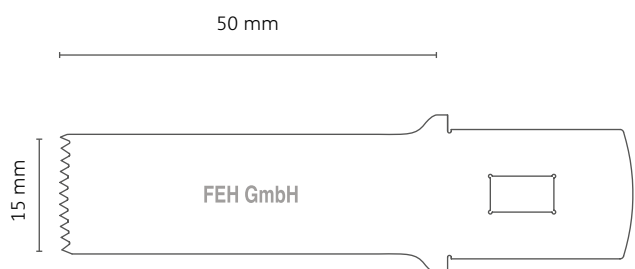
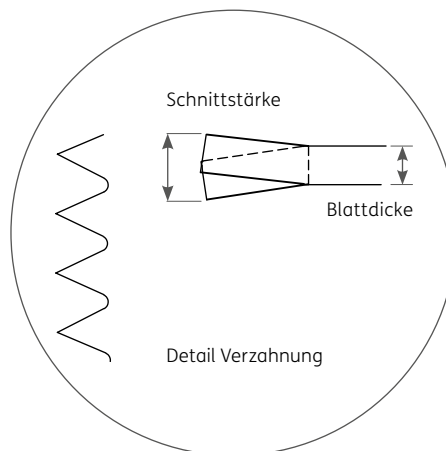

STERILE 

AESFULAP®
ACCULAN®

BLATTDICKE/ SCHNITTSTÄRKE	SCHNITT- BREITE	NUTZBARE LÄNGE	ARTIKEL-NR. ORIGINAL	ARTIKEL-NR. FEH
0,5 / 0,8 mm	15 mm	50 mm	GC216R	G1263439S

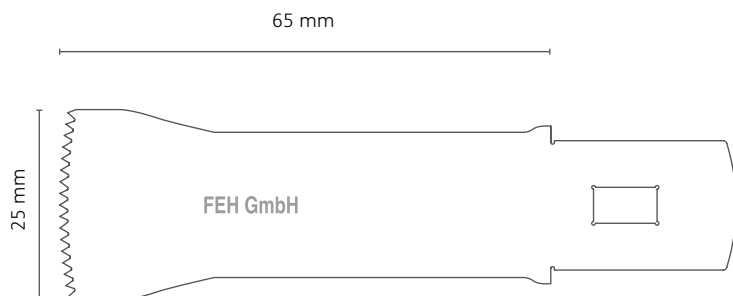

STERILE 

AESFULAP®
ACCULAN®

SCHNITTSTÄRKE	SCHNITT- BREITE	NUTZBARE LÄNGE	ARTIKEL-NR. ORIGINAL	ARTIKEL-NR. FEH
0,9 mm	25 mm	65 mm	GE253R	G12716618S

Synthes ist die Handelsmarke von Synthes.
 Aesculap ist die Handelsmarke der B. Braun Melsungen AG.
 Aesculap Acculan ist die Handelsm. der B. Braun Melsungen AG.
 Stryker ist die Handelsmarke der Stryker Corporation.
 Hall ist die Handelsmarke der ConMed Corporation.
 Linvatec ist die Handelsmarke der ConMed Corporation.
 3M ist die Handelsmarke der ConMed Corporation.
 De Soutter ist die Handelsmarke von De Soutter.

FEH GmbH ist nicht affiliert mit diesen Firmen.

 **Made in Germany**
 als Garant für Qualität.

Bei der Produktion setzen wir auf den Standort Deutschland.

Zertifiziert sind wir nach MPG, DIN EN ISO 13485: 2016
 Unsere Sägeblätter tragen die Kennung des TÜV Nord CE0044.



BESTELL- & ANGEBOTSFORMULAR



FEH Medizintechnik

MEDIZINTECHNISCHE PRODUKTE

FEH GmbH

Am Stadtwalde 15
48432 Rheine

T: +49 (0) 59 71 - 98 56 63

F: +49 (0) 59 71 - 8 70 00

E: Zentrale@FEH-Med.com

W: www.FEH-Med.com

Firma/Krankenhaus
Kd. Nr.
Ansprechpartner
Anschrift
Plz Ort.
Fon
Fax
E-Mail

SÄGEBLÄTTER

TYP SÄGEBLATT	ARTIKEL-NR. ORIGINAL	ARTIKEL-NR. FEH	MENGE

Bestellung Anfrage

JETZT BESTELLEN

FAX: Bitte das obenstehende Formular vollständig ausfüllen und **per Fax zurücksenden an +49 (0) 59 71- 87 00 0**

POST: Schicken Sie Ihre Bestellung in einem Kuvert an:
FEH GmbH, Am Stadtwalde 15, 48432 Rheine

MAIL: Bestellung einscannen und an **zentrale@feh-med.com** senden oder digitales Bestellformular von **www.feh-med.com** verwenden

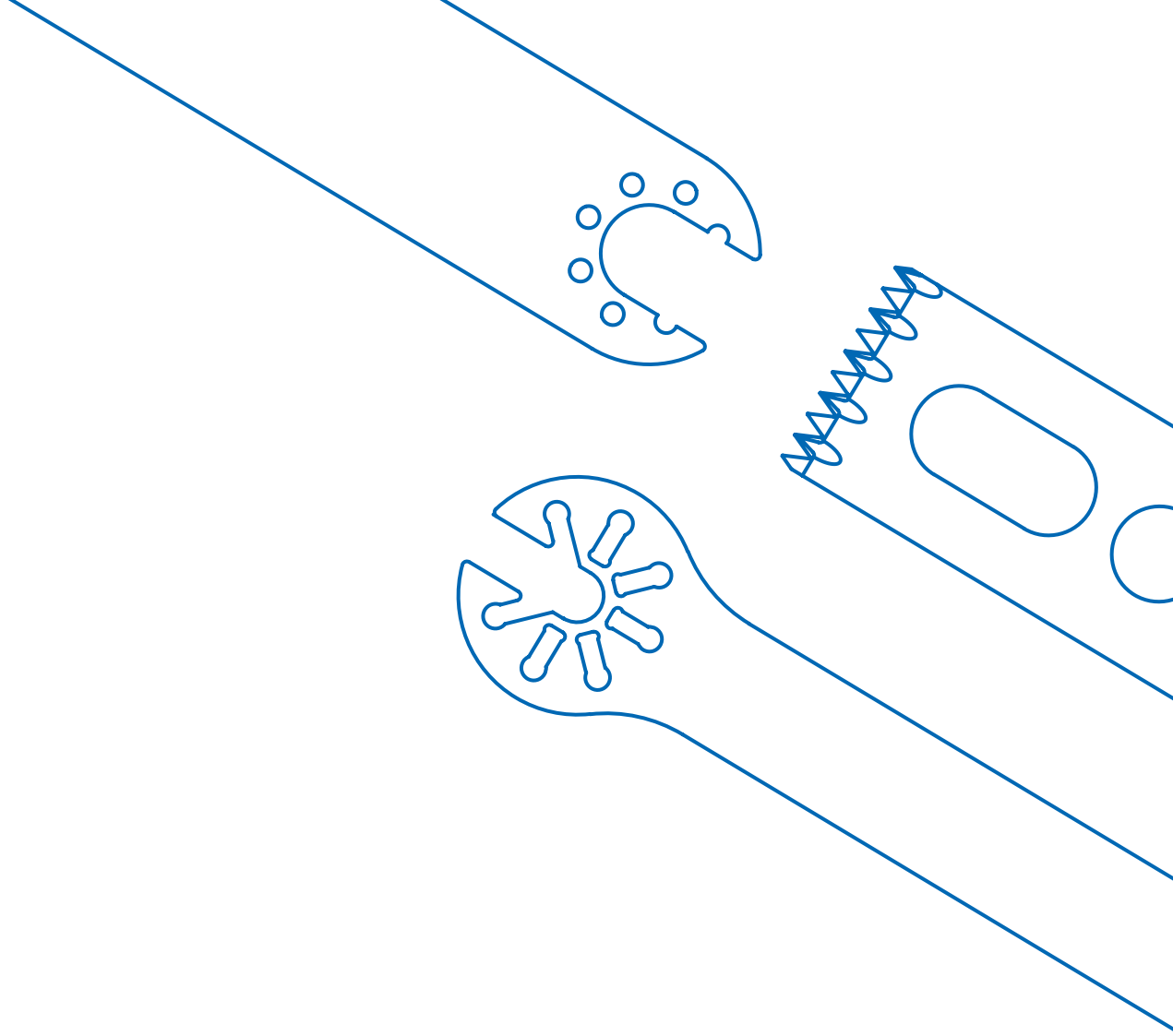

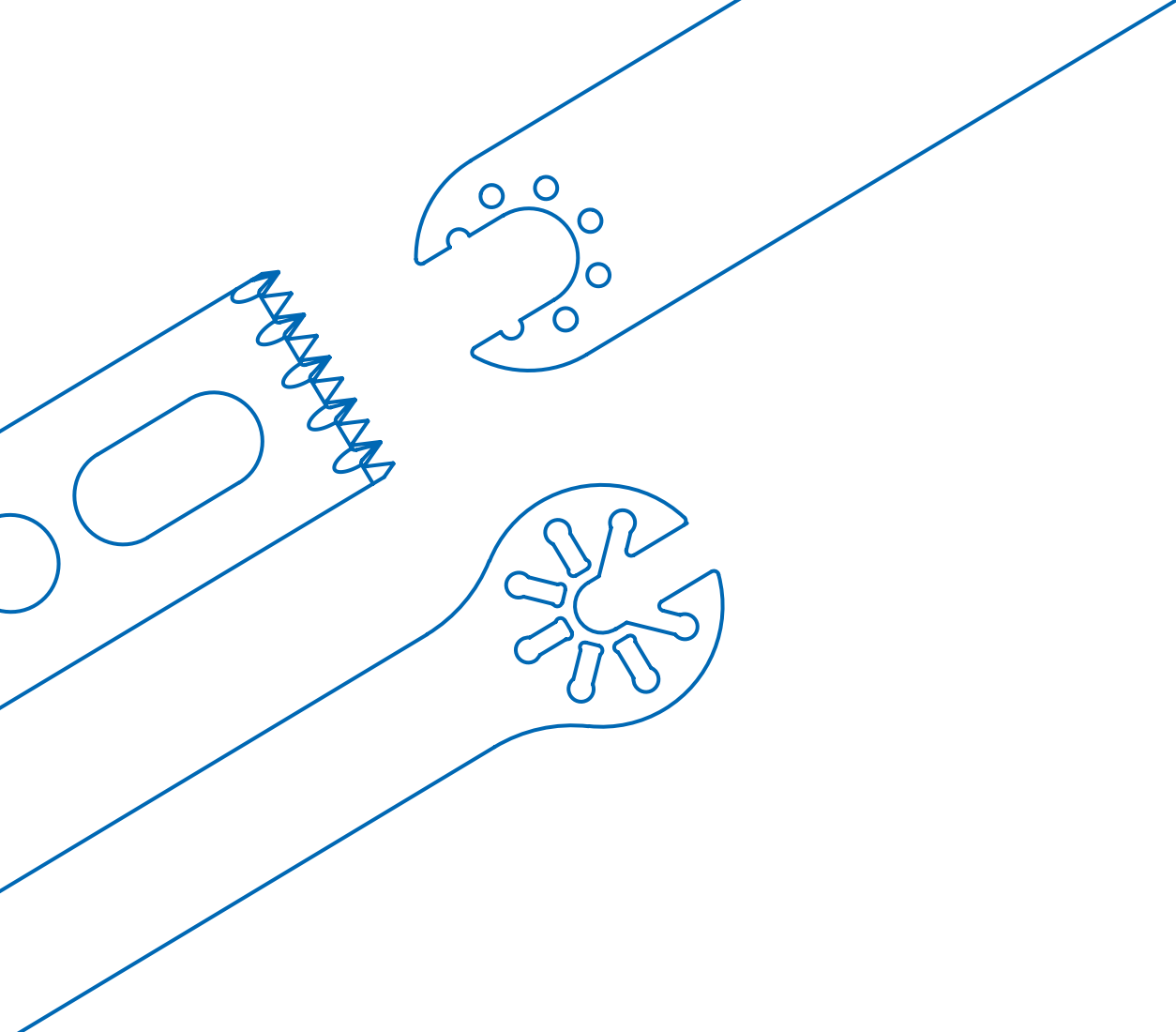

WIR HABEN LÖSUNGEN FÜR JEDES ANWENDUNGSPROBLEM!

Durch die hohe Qualität und Präzision der anwenderorientierten Produkte kann ein optimales Operationsergebnis erreicht werden.

Sprechen Sie uns an, wir haben für Sie die adäquate Lösung. Qualität, Kosteneffizienz und Kundenservice sind die Eckpfeiler unseres unternehmerischen Handelns.

FEH GmbH
Medizintechnische Produkte

Am Stadtwalde 15
48432 Rheine, Germany

Tel: +49 (0) 59 71 - 98 56 63
Fax: +49 (0) 59 71 - 8 70 00
Zentrale@FEH-Med.com
www.FEH-Med.com