

**FEH Medizintechnik**

MEDIZINTECHNISCHE PRODUKTE



# SÄGEBLÄTTER

MIT UNS SCHNEIDEN SIE GUT AB



## Höchste Anforderungen

an Qualität und Präzision sind bei chirurgischen Instrumenten unabdingbar. So werden nur biokompatible Stähle mit hoher Säurebeständigkeit verwendet, die auch den Anforderungen der Sterilisation standhalten.

Wir verfügen über ein langjähriges Know-how in der Herstellung von chirurgischen Instrumenten und wissen worauf es ankommt:

- Präzision und Qualität
- Liefertreue und kurze Reaktionszeit
- Preis- und Leistungsverhältnis

Sonderanfertigungen werden in enger Zusammenarbeit mit dem Kunden entwickelt.

## Unser Know-how

Die Anforderungen an chirurgische Instrumente sind hoch. Daher unterliegen unsere Produkte den besten Fertigungsprozessen und einer ständigen Qualitätskontrolle. Die Produktion wird durch ein Qualitätsmanagementsystem nach DIN ISO EN 13485: 2016 durchgeführt und überwacht.

Die Oberflächen der Sägeblätter werden vergütet, um bei der Anwendung am Knochen die Reibung, und damit durch Temperaturanstieg erzeugte Gewebnekrosen zu minimieren. Somit gibt es eine Reihe von Möglichkeiten das Operationsergebniss zu optimieren.





## Maße und Bezeichnungen

- 1 SCHNITTBREITE**  
Die Breite des Sägeblattes gemessen an der Außenkante der beiden äußeren Zähne.
- 2 NUTZBARE LÄNGE**  
Maximale Eindringtiefe der Schneide
- 3 SCHNITTSTÄRKE**  
Die Stärke des Sägeblattes gemessen an der Schneidekante.
- 4 MATERIALDICKE**  
Die Dicke des Sägeblattes - überstehende Verzahnung nicht eingeschlossen.

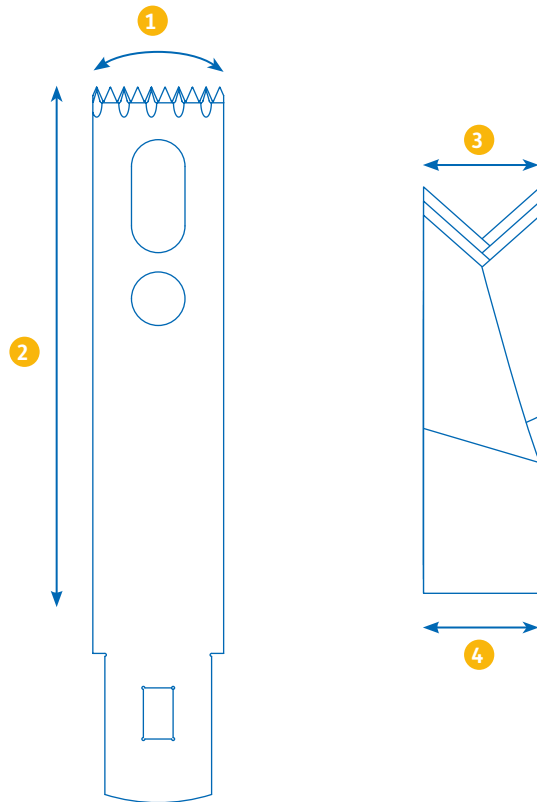

## Bestellungsablauf

			SYNTHES®	AESCULAP®	AESCULAP® ACCULAN®	
						Wählen Sie die verwendete Antriebsmaschine
STERILE			<b>ARTIKELNUMMER FEH UNSTERIL</b>			
SCHNITT-STÄRKE (mm)	SCHNITT-BREITE (mm)	NUTZBARE LÄNGE (mm)	G 211090	G 231090	G 221090	Ihre Bestellnummer für <b>UNSTERILE</b> Sägeblätter: Artikelnummern für unsterile Sägeblätter enthalten kein „S“
1,00	22	115				
STERILE			<b>ARTIKELNUMMER FEH STERIL</b>			
SCHNITT-STÄRKE (mm)	SCHNITT-BREITE (mm)	NUTZBARE LÄNGE (mm)	G 211090 S	G 231090 S	G 221090 S	Ihre Bestellnummer für <b>STERILE</b> Sägeblätter: bitte das „S“ bei der Artikelnummer mit angeben
1,00	22	115				

## Sofort Verfügbare Sägeblätter:

AESCULAP®, AESCULAP® ACCULAN®, CONMED LINVATEC® 3M®, DE SOUTER®, HALL®, STRYKER®, STRYKER® SYSTEM S, STRYKER® PLUS, SYNTHES®

**Weitere Ausführungen sind auf Anfrage lieferbar!**



## Kniesägeblätter

BITTE BEACHTEN SIE UNSEREN BESTELLBLAUF AUF SEITE 3 FÜR DIE UNSTERILEN SÄGEBLÄTTER

Unsere universell einsetzbaren Sägeblätter für alle Anwendungen der großen und kleinen Knochenchirurgie überzeugen durch

- geringe Eigenschwingung
- geringe Temperaturentwicklung
- hohe Schärfe
- hohe Schnittpräzision

Die Sägeblätter werden aus besonderem Edelstahl gefertigt, der auch bei hoher Belastung keinen Abrieb aufweist.

Alle Sägeblätter können wir Ihnen in steriler, wie auch in unsteriler Version anbieten.

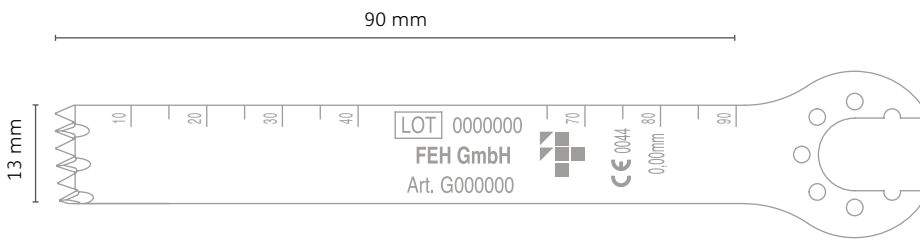
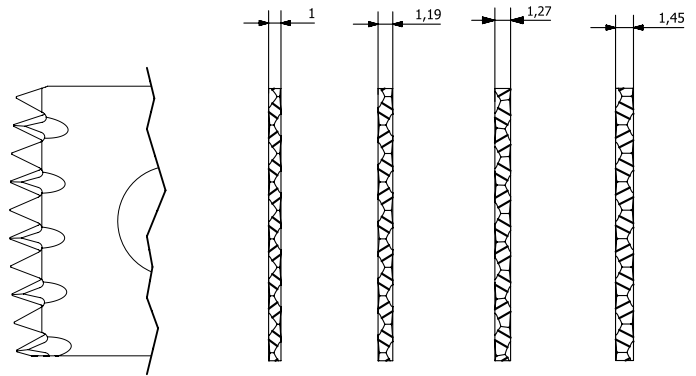

STERILE

SYNTHES®	AESCLAP®	AESCLAP® ACCULAN®	STRYKER® SYSTEM S	STRYKER®	HALL®	CONMED LINVATEC® 3M®	DE SOUTTER®	ARTHREX

SCHNITT-STÄRKE (mm)	SCHNITT-BREITE (mm)	NUTZBARE LÄNGE (mm)	ARTIKELNUMMER FEH								
0,89=0,90	13	90	G 211250S	G 221250S	G 251250S	G 271250S	G 241250S	G 231250S	G 261250S	G 281250S	G 291250S
1,00	13	90	G 211200S	G 221200S	G 251200S	G 271200S	G 241200S	G 231200S	G 261200S	G 281200S	G 291200S
1,19	13	90	G 211210S	G 221210S	G 251210S	G 271210S	G 241210S	G 231210S	G 261210S	G 281210S	G 291210S
1,27	13	90	G 211220S	G 221220S	G 251220S	G 271220S	G 241220S	G 231220S	G 261220S	G 281220S	G 291220S
1,37	13	90	G 211240S	G 221240S	G 251240S	G 271240S	G 241240S	G 231240S	G 261240S	G 281240S	G 291240S
1,45	13	90	G 211230S	G 221230S	G 251230S	G 271230S	G 241230S	G 231230S	G 261230S	G 281230S	G 291230S







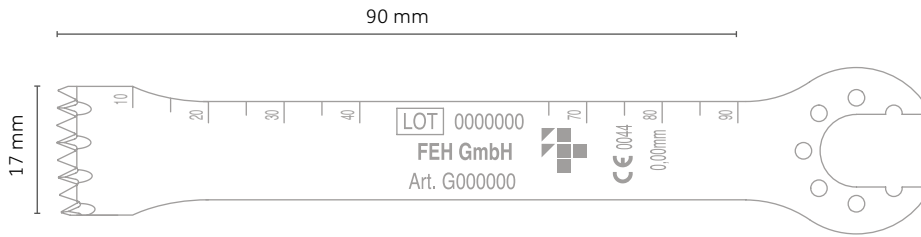

## Kniesägeblätter

**BITTE BEACHTEN SIE UNSEREN BESTELLABLAUF AUF SEITE 3 FÜR DIE UNSTERILEN SÄGEBLÄTTER**



**STERILE** 

<b>SYNTHES®</b>	<b>AESCLAP®</b>	<b>AESCLAP® ACCULAN®</b>	<b>STRYKER® SYSTEM S</b>	<b>STRYKER®</b>	<b>HALL®</b>	<b>CONMED LINVATEC® 3M®</b>	<b>DE SOUTTER®</b>	<b>ARTHREX</b>
								

SCHNITT-STÄRKE (mm)	SCHNITT-BREITE (mm)	NUTZBARE LÄNGE (mm)	ARTIKELNUMMER FEH								
0,89=0,90	17	90	G 211450AS	G 221450AS	G 251450AS	G 271450AS	G 241450AS	G 231450AS	G 261450AS	G 281450AS	G 291450AS
1,00	17	90	G 211400AS	G 221400AS	G 251400AS	G 271400AS	G 241400AS	G 231400AS	G 261400AS	G 281400AS	G 291400AS
1,19	17	90	G 211410AS	G 221410AS	G 251410AS	G 271410AS	G 241410AS	G 231410AS	G 261410AS	G 281410AS	G 291410AS
1,27	17	90	G 211420AS	G 221420AS	G 251420AS	G 271420AS	G 241420AS	G 231420AS	G 261420AS	G 281420AS	G 291420AS
1,37	17	90	G 211440AS	G 221440AS	G 251440AS	G 271440AS	G 241440AS	G 231440AS	G 261440AS	G 281440AS	G 291440AS
1,45	17	90	G 211430AS	G 221430AS	G 251430AS	G 271430AS	G 241430AS	G 231430AS	G 261430AS	G 281430AS	G 291430AS
1,47	17	90	G 211460AS	G 221460AS	G 251460AS	G 271460AS	G 241460AS	G 231460AS	G 261460AS	G 281460AS	G 291460AS

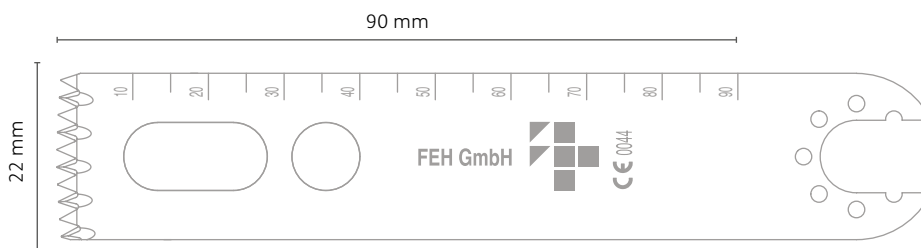

**STERILE** 

<b>SYNTHES®</b>	<b>AESCLAP®</b>	<b>AESCLAP® ACCULAN®</b>	<b>STRYKER® SYSTEM S</b>	<b>STRYKER®</b>	<b>HALL®</b>	<b>CONMED LINVATEC® 3M®</b>	<b>DE SOUTTER®</b>	<b>ARTHREX</b>
								

SCHNITT-STÄRKE (mm)	SCHNITT-BREITE (mm)	NUTZBARE LÄNGE (mm)	ARTIKELNUMMER FEH								
0,89=0,90	22	90	G 211150S	G 221150S	G 251150S	G 271150S	G 241150S	G 231150S	G 261150S	G 281150S	G 291150S
1,00	22	90	G 211100S	G 221100S	G 251100S	G 271100S	G 241100S	G 231100S	G 261100S	G 281100S	G 291100S
1,19	22	90	G 211110S	G 221110S	G 251110S	G 271110S	G 241110S	G 231110S	G 261110S	G 281110S	G 291110S
1,27	22	90	G 211120S	G 221120S	G 251120S	G 271120S	G 241120S	G 231120S	G 261120S	G 281120S	G 291120S
1,37	22	90	G 211140S	G 221140S	G 251140S	G 271140S	G 241140S	G 231140S	G 261140S	G 281140S	G 291140S
1,45	22	90	G 211130S	G 221130S	G 251130S	G 271130S	G 241130S	G 231130S	G 261130S	G 281130S	G 291130S
1,47	22	90	G 211160S	G 221160S	G 251160S	G 271160S	G 241160S	G 231160S	G 261160S	G 281160S	G 291160S



## Kniesägeblätter

BITTE BEACHTEN SIE UNSEREN BESTELLABLAUF  
AUF SEITE 3 FÜR DIE UNSTERILEN SÄGEBLÄTTER

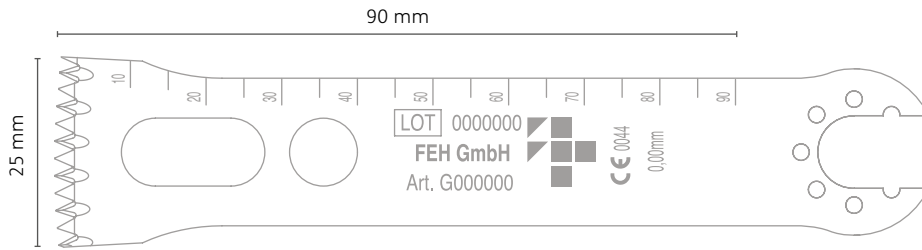

STERILE

SYNTHES®	AESCLAP®	AESCLAP® ACCULAN®	STRYKER® SYSTEM S	STRYKER®	HALL®	CONMED LINVATEC® 3M®	DE SOUTTER®	ARTHREX

SCHNITT-STÄRKE (mm)	SCHNITT-BREITE (mm)	NUTZBARE LÄNGE (mm)	ARTIKELNUMMER FEH								
0,89=0,90	25	90	G 211550AS	G 221550AS	G 251550AS	G 271550AS	G 241550AS	G 231550AS	G 261550AS	G 281550AS	G 291550AS
1,00	25	90	G 211500AS	G 221500AS	G 251500AS	G 271500AS	G 241500AS	G 231500AS	G 261500AS	G 281500AS	G 291500AS
1,19	25	90	G 211510AS	G 221510AS	G 251510AS	G 271510AS	G 241510AS	G 231510AS	G 261510AS	G 281510AS	G 291510AS
1,27	25	90	G 211520AS	G 221520AS	G 251520AS	G 271520AS	G 241520AS	G 231520AS	G 261520AS	G 281520AS	G 291520AS
1,37	25	90	G 211540AS	G 221540AS	G 251540AS	G 271540AS	G 241540AS	G 231540AS	G 261540AS	G 281540AS	G 291540AS
1,45	25	90	G 211530AS	G 221530AS	G 251530AS	G 271530AS	G 241530AS	G 231530AS	G 261530AS	G 281530AS	G 291530AS
1,47	25	90	G 211560AS	G 221560AS	G 251560AS	G 271560AS	G 241560AS	G 231560AS	G 261560AS	G 281560AS	G 291560AS

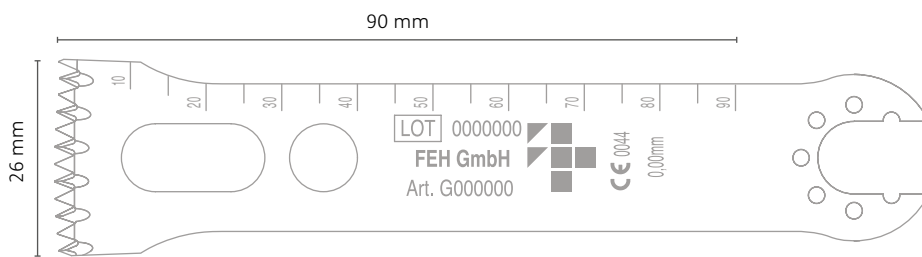

STERILE

SYNTHES®	AESCLAP®	AESCLAP® ACCULAN®	STRYKER® SYSTEM S	STRYKER®	HALL®	CONMED LINVATEC® 3M®	DE SOUTTER®	ARTHREX

SCHNITT-STÄRKE (mm)	SCHNITT-BREITE (mm)	NUTZBARE LÄNGE (mm)	ARTIKELNUMMER FEH								
0,89=0,90	26	90	G 211350AS	G 221350AS	G 251350AS	G 271350AS	G 241350AS	G 231350AS	G 261350AS	G 281350AS	G 291350AS
1,00	26	90	G 211300AS	G 221300AS	G 251300AS	G 271300AS	G 241300AS	G 231300AS	G 261300AS	G 281300AS	G 291300AS
1,19	26	90	G 211310AS	G 221310AS	G 251310AS	G 271310AS	G 241310AS	G 231310AS	G 261310AS	G 281310AS	G 291310AS
1,27	26	90	G 211320AS	G 221320AS	G 251320AS	G 271320AS	G 241320AS	G 231320AS	G 261320AS	G 281320AS	G 291320AS
1,37	26	90	G 211340AS	G 221340AS	G 251340AS	G 271340AS	G 241340AS	G 231340AS	G 261340AS	G 281340AS	G 291340AS
1,45	26	90	G 211330AS	G 221330AS	G 251330AS	G 271330AS	G 241330AS	G 231330AS	G 261330AS	G 281330AS	G 291330AS
1,47	26	90	G 211360AS	G 221360AS	G 251360AS	G 271360AS	G 241360AS	G 231360AS	G 261360AS	G 281360AS	G 291360AS



## Kniesägeblätter Titan beschichtet

Titanbeschichtete Schnittflächen für besonders lange Lebensdauer.

Unsere universell einsetzbaren Sägeblätter für alle Anwendungen der großen und kleinen Knochenchirurgie überzeugen durch

- geringe Eigenschwingung
- geringe Temperaturentwicklung
- hohe Schärfe
- hohe Schnittpräzision

Die Sägeblätter werden aus besonderem Edelstahl gefertigt, der auch bei hoher Belastung keinen Abrieb aufweist.

Alle Sägeblätter können wir Ihnen in steriler, wie auch in unsteriler Version anbieten.

BITTE BEACHTEN SIE UNSEREN BESTELLABLAUF AUF SEITE 3 FÜR DIE UNSTERILEN SÄGEBLÄTTER

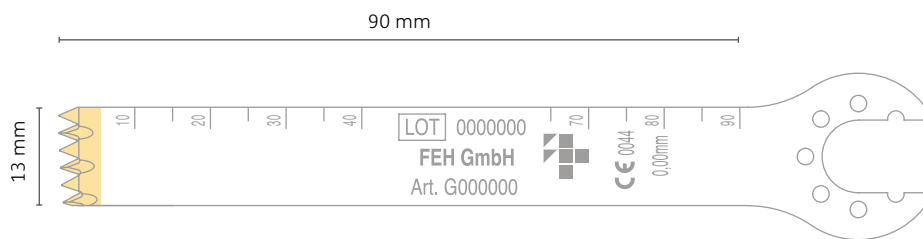
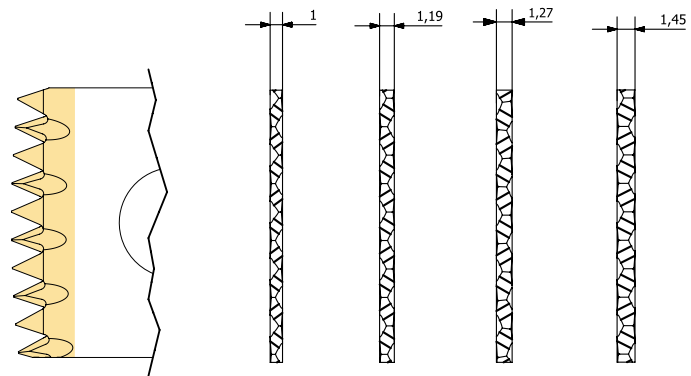

STERILE 

SYNTHES®	AESCULAP®	AESCULAP® ACCULAN®	STRYKER® SYSTEM S	STRYKER®	HALL®	CONMED LINVATEC® 3M®	DE SOUTTER®	ARTHREX
								

SCHNITT-STÄRKE (mm)	SCHNITT-BREITE (mm)	NUTZBARE LÄNGE (mm)	ARTIKELNUMMER FEH								
0,89=0,90	13	90	G 211250BS	G 221250BS	G 251250BS	G 271250BS	G 241250BS	G 231250BS	G 261250BS	G 281250BS	G 291250BS
1,00	13	90	G 211200BS	G 221200BS	G 251200BS	G 271200BS	G 241200BS	G 231200BS	G 261200BS	G 281200BS	G 291200BS
1,19	13	90	G 211210BS	G 221210BS	G 251210BS	G 271210BS	G 241210BS	G 231210BS	G 261210BS	G 281210BS	G 291210BS
1,27	13	90	G 211220BS	G 221220BS	G 251220BS	G 271220BS	G 241220BS	G 231220BS	G 261220BS	G 281220BS	G 291220BS
1,37	13	90	G 211240BS	G 221240BS	G 251240BS	G 271240BS	G 241240BS	G 231240BS	G 261240BS	G 281240BS	G 291240BS
1,45	13	90	G 211230BS	G 221230BS	G 251230BS	G 271230BS	G 241230BS	G 231230BS	G 261230BS	G 281230BS	G 291230BS

## Kniesägeblätter

BITTE BEACHTEN SIE UNSEREN BESTELLABLAUF  
AUF SEITE 3 FÜR DIE UNSTERILEN SÄGEBLÄTTER

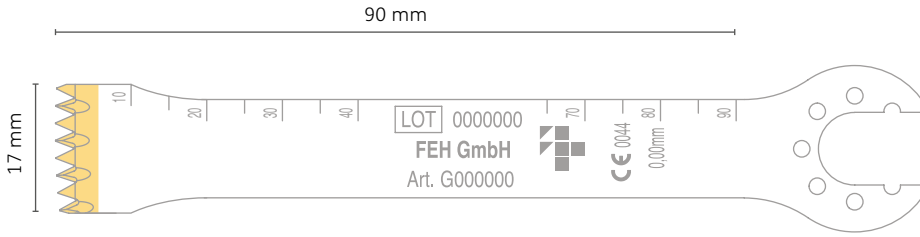

STERILE 

SYNTHES®	AESCLAP®	AESCLAP® ACCULAN®	STRYKER® SYSTEM S	STRYKER®	HALL®	CONMED LINVATEC® 3M®	DE SOUTTER®	ARTHREX
								

SCHNITT- STÄRKE (mm)	SCHNITT- BREITE (mm)	NUTZBARE LÄNGE (mm)	ARTIKELNUMMER FEH								
0,89=0,90	17	90	G 211450ABS	G 221450ABS	G 251450ABS	G 271450ABS	G 241450ABS	G 231450ABS	G 261450ABS	G 281450ABS	G 291450ABS
1,00	17	90	G 211400ABS	G 221400ABS	G 251400ABS	G 271400ABS	G 241400ABS	G 231400ABS	G 261400ABS	G 281400ABS	G 291400ABS
1,19	17	90	G 211410ABS	G 221410ABS	G 251410ABS	G 271410ABS	G 241410ABS	G 231410ABS	G 261410ABS	G 281410ABS	G 291410ABS
1,27	17	90	G 211420ABS	G 221420ABS	G 251420ABS	G 271420ABS	G 241420ABS	G 231420ABS	G 261420ABS	G 281420ABS	G 291420ABS
1,37	17	90	G 211440ABS	G 221440ABS	G 251440ABS	G 271440ABS	G 241440ABS	G 231440ABS	G 261440ABS	G 281440ABS	G 291440ABS
1,45	17	90	G 211430ABS	G 221430ABS	G 251430ABS	G 271430ABS	G 241430ABS	G 231430ABS	G 261430ABS	G 281430ABS	G 291430ABS
1,47	17	90	G 211460ABS	G 221460ABS	G 251460ABS	G 271460ABS	G 241460ABS	G 231460ABS	G 261460ABS	G 281460ABS	G 291460ABS

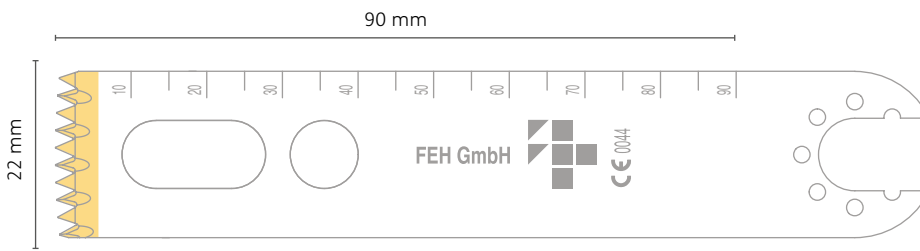

STERILE 

SYNTHES®	AESCLAP®	AESCLAP® ACCULAN®	STRYKER® SYSTEM S	STRYKER®	HALL®	CONMED LINVATEC® 3M®	DE SOUTTER®	ARTHREX
								

SCHNITT- STÄRKE (mm)	SCHNITT- BREITE (mm)	NUTZBARE LÄNGE (mm)	ARTIKELNUMMER FEH								
0,89=0,90	22	90	G 211150BS	G 221150BS	G 251150BS	G 271150BS	G 241150BS	G 231150BS	G 261150BS	G 281150BS	G 291150BS
1,00	22	90	G 211100BS	G 221100BS	G 251100BS	G 271100BS	G 241100BS	G 231100BS	G 261100BS	G 281100BS	G 291100BS
1,19	22	90	G 211110BS	G 221110BS	G 251110BS	G 271110BS	G 241110BS	G 231110BS	G 261110BS	G 281110BS	G 291110BS
1,27	22	90	G 211120BS	G 221120BS	G 251120BS	G 271120BS	G 241120BS	G 231120BS	G 261120BS	G 281120BS	G 291120BS
1,37	22	90	G 211140BS	G 221140BS	G 251140BS	G 271140BS	G 241140BS	G 231140BS	G 261140BS	G 281140BS	G 291140BS
1,45	22	90	G 211130BS	G 221130BS	G 251130BS	G 271130BS	G 241130BS	G 231130BS	G 261130BS	G 281130BS	G 291130BS
1,47	22	90	G 211160BS	G 221160BS	G 251160BS	G 271160BS	G 241160BS	G 231160BS	G 261160BS	G 281160BS	G 291160BS





## Kniesägeblätter

BITTE BEACHTEN SIE UNSEREN BESTELLABLAUF AUF SEITE 3 FÜR DIE UNSTERILEN SÄGEBLÄTTER

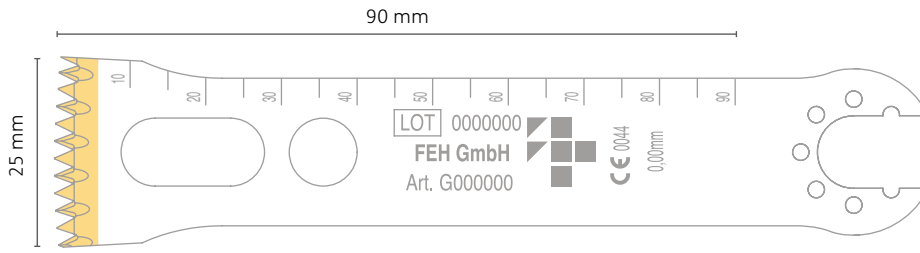

STERILE 

SYNTHES®	AESCLAP®	AESCLAP® ACCULAN®	STRYKER® SYSTEM S	STRYKER®	HALL®	CONMED LINVATEC® 3M®	DE SOUTTER®	ARTHREX
								

SCHNITT-STÄRKE (mm)	SCHNITT-BREITE (mm)	NUTZBARE LÄNGE (mm)	ARTIKELNUMMER FEH								
0,89=0,90	25	90	G 211550ABS	G 221550ABS	G 251550ABS	G 271550ABS	G 241550ABS	G 231550ABS	G 261550ABS	G 281550ABS	G 291550ABS
1,00	25	90	G 211500ABS	G 221500ABS	G 251500ABS	G 271500ABS	G 241500ABS	G 231500ABS	G 261500ABS	G 281500ABS	G 291500ABS
1,19	25	90	G 211510ABS	G 221510ABS	G 251510ABS	G 271510ABS	G 241510ABS	G 231510ABS	G 261510ABS	G 281510ABS	G 291510ABS
1,27	25	90	G 211520ABS	G 221520ABS	G 251520ABS	G 271520ABS	G 241520ABS	G 231520ABS	G 261520ABS	G 281520ABS	G 291520ABS
1,37	25	90	G 211540ABS	G 221540ABS	G 251540ABS	G 271540ABS	G 241540ABS	G 231540ABS	G 261540ABS	G 281540ABS	G 291540ABS
1,45	25	90	G 211530ABS	G 221530ABS	G 251530ABS	G 271530ABS	G 241530ABS	G 231530ABS	G 261530ABS	G 281530ABS	G 291530ABS
1,47	25	90	G 211560ABS	G 221560ABS	G 251560ABS	G 271560ABS	G 241560ABS	G 231560ABS	G 261560ABS	G 281560ABS	G 291560ABS

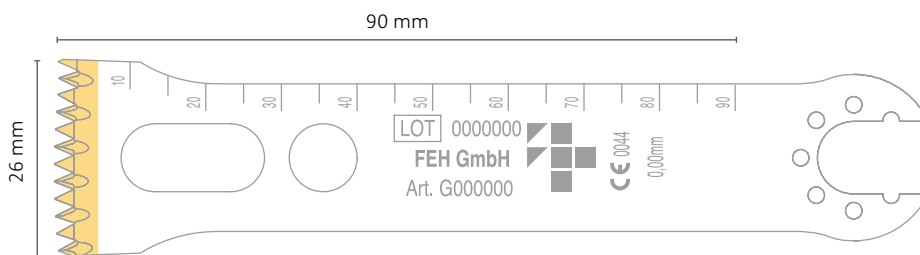

STERILE 

SYNTHES®	AESCLAP®	AESCLAP® ACCULAN®	STRYKER® SYSTEM S	STRYKER®	HALL®	CONMED LINVATEC® 3M®	DE SOUTTER®	STRYKER® PLUS
								

SCHNITT-STÄRKE (mm)	SCHNITT-BREITE (mm)	NUTZBARE LÄNGE (mm)	ARTIKELNUMMER FEH								
0,89=0,90	26	90	G 211350ABS	G 221350ABS	G 251350ABS	G 271350ABS	G 241350ABS	G 231350ABS	G 261350ABS	G 281350ABS	G 291350ABS
1,00	26	90	G 211300ABS	G 221300ABS	G 251300ABS	G 271300ABS	G 241300ABS	G 231300ABS	G 261300ABS	G 281300ABS	G 291300ABS
1,19	26	90	G 211310ABS	G 221310ABS	G 251310ABS	G 271310ABS	G 241310ABS	G 231310ABS	G 261310ABS	G 281310ABS	G 291310ABS
1,27	26	90	G 211320ABS	G 221320ABS	G 251320ABS	G 271320ABS	G 241320ABS	G 231320ABS	G 261320ABS	G 281320ABS	G 291320ABS
1,37	26	90	G 211340ABS	G 221340ABS	G 251340ABS	G 271340ABS	G 241340ABS	G 231340ABS	G 261340ABS	G 281340ABS	G 291340ABS
1,45	26	90	G 211330ABS	G 221330ABS	G 251330ABS	G 271330ABS	G 241330ABS	G 231330ABS	G 261330ABS	G 281330ABS	G 291330ABS
1,47	26	90	G 211360ABS	G 221360ABS	G 251360ABS	G 271360ABS	G 241360ABS	G 231360ABS	G 261360ABS	G 281360ABS	G 291360ABS

## STRYKER®

### Sägeblätter für Sagittalsägeaufsatz

BITTE BEACHTEN SIE UNSEREN BESTELLABLAUF  
AUF SEITE 3 FÜR DIE UNSTERILEN SÄGEBLÄTTER

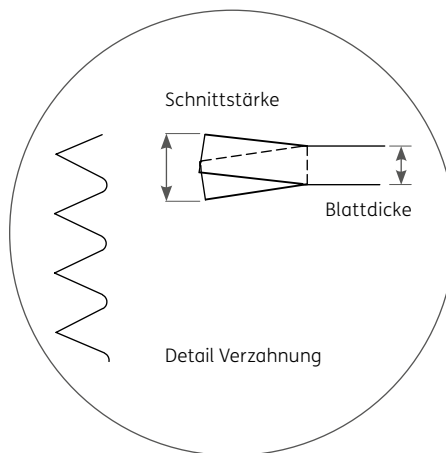
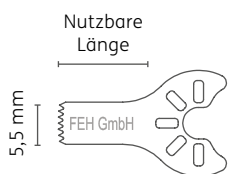

STERILE 

STRYKER®

BLATTDICKE/ SCHNITTSTÄRKE (mm)	SCHNITT- BREITE (mm)	NUTZBARE LÄNGE (mm)	ARTIKEL-NR. ORIGINAL	ARTIKEL-NR. FEH
0,4 / 0,6	5,5	11,5	KM3-410	G 1364 1020 S
0,4 / 0,6	5,5	18	KM3-412	G 1316 1020 S

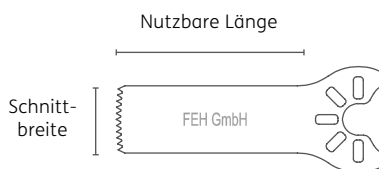
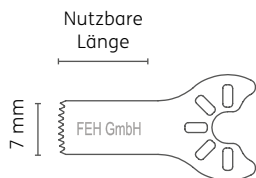

STERILE 

STRYKER®

BLATTDICKE/ SCHNITTSTÄRKE (mm)	SCHNITT- BREITE (mm)	NUTZBARE LÄNGE (mm)	ARTIKEL-NR. ORIGINAL	ARTIKEL-NR. FEH
0,5 / 0,7	7	15	KM33-103	G 1364 158 S
0,5 / 0,6	7	18,5	KM33-114	G 1317 1522 S
0,5 / 0,7	7	29,5	KM33-115	G 1342 158 S

STERILE 

STRYKER®

BLATTDICKE/ SCHNITTSTÄRKE (mm)	SCHNITT- BREITE (mm)	NUTZBARE LÄNGE (mm)	ARTIKEL-NR. ORIGINAL (mm)	ARTIKEL-NR. FEH
0,40/0,60	9	25	KM3-511	G 1330 2420 S
0,40/0,60	9	31	KM3-525	G 1344 2420 S
0,40/0,60	9,5	11,5	KM3-411	G 1364 2520 S
0,40/0,60	9,8	25	KM3-111	G 1330 2620 S
0,40/0,60	9,8	31	KM3-125	G 1344 2620 S
0,50/0,70	9,8	25	KM33-111	G 1330 268 S
0,50/0,70	9,8	18,5	KM33-105	G 1317 268 S
0,50/0,60	10	31	KM33-125	G 1344 278 S

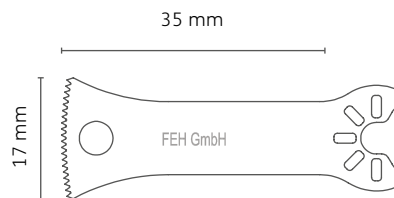

STERILE 

STRYKER®

BLATTDICKE/ SCHNITTSTÄRKE (mm)	SCHNITT- BREITE (mm)	NUTZBARE LÄNGE (mm)	ARTIKEL-NR. ORIGINAL	ARTIKEL-NR. FEH
0,50/0,70	12,5	34,5	KM33-206	G 1333 358 AS

STERILE 

STRYKER®

BLATTDICKE/ SCHNITTSTÄRKE (mm)	SCHNITT- BREITE (mm)	NUTZBARE LÄNGE (mm)	ARTIKEL-NR. ORIGINAL	ARTIKEL-NR. FEH
0,50/0,50	17	35	KM33-104	G 1346 497 AS



## HALL® SAGITTAL

Sägeblätter für Sagittalsägeaufsatz

BITTE BEACHTEN SIE UNSEREN BESTELLABLAUF AUF SEITE 3 FÜR DIE UNSTERILEN SÄGEBLÄTTER

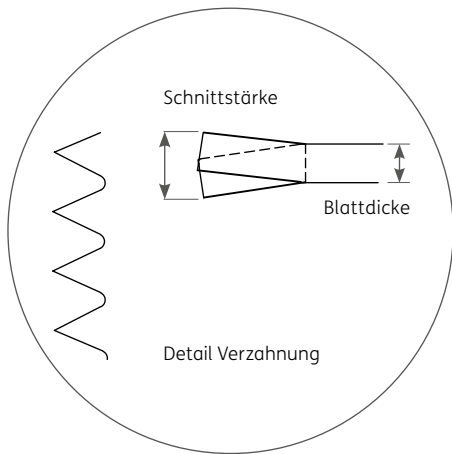
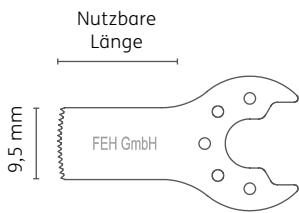

STERILE 

				HALL®
BLATTDICKE/ SCHNITTSTÄRKE (mm)	SCHNITT- BREITE (mm)	NUTZBARE LÄNGE (mm)	ARTIKEL-NR. ORIGINAL	ARTIKEL-NR. FEH
0,40/0,60	9,5	16	KM-3104	G 1612 2520 S
0,40/0,60	9,5	18,5	5044-145	G 1617 2520 S
0,40/0,60	9,5	25,5	KM-3101	G 1632 2520 S

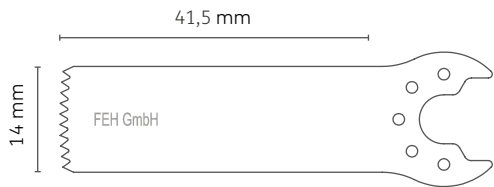

STERILE 

				HALL®
BLATTDICKE/ SCHNITTSTÄRKE (mm)	SCHNITT- BREITE (mm)	NUTZBARE LÄNGE (mm)	ARTIKEL-NR. ORIGINAL	ARTIKEL-NR. FEH
0,40/0,60	14	41,5	KM-3100C	G 1652 4020 S

## HALL® OSZILLIEREND

Sägeblätter für oszillierenden Sägeaufsatz

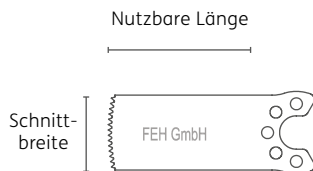
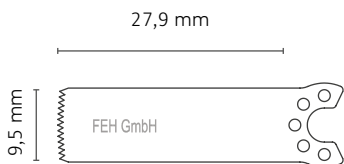

STERILE 

				HALL®
BLATTDICKE/ SCHNITTSTÄRKE (mm)	SCHNITT- BREITE (mm)	NUTZBARE LÄNGE (mm)	ARTIKEL-NR. ORIGINAL	ARTIKEL-NR. FEH
0,40/0,60	9,5	27,9	KM-3004	G 1766 2520 S

STERILE 

				HALL®
BLATTDICKE/ SCHNITTSTÄRKE (mm)	SCHNITT- BREITE (mm)	NUTZBARE LÄNGE (mm)	ARTIKEL-NR. ORIGINAL	ARTIKEL-NR. FEH
0,40/0,60	9,5	18,5	KM-3005	G 1717 2520 S
0,40/0,60	10	31	KM-3002	G 1744 2720 S



## SYNTHES® COLIBRI

Sägeblätter für oszillierenden Sägeaufsatz

BITTE BEACHTEN SIE UNSEREN BESTELLABLAUF  
AUF SEITE 3 FÜR DIE UNSTERILEN SÄGEBLÄTTER

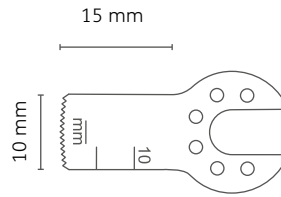
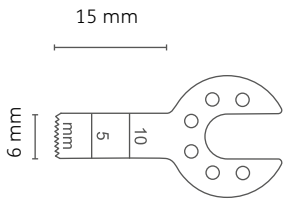

STERILE

SYNTHES®  
COLIBRI

BLATTDICKE/ SCHNITTSTÄRKE (mm)	SCHNITT- BREITE (mm)	NUTZBARE LÄNGE (mm)	ARTIKEL-NR. ORIGINAL	ARTIKEL-NR. FEH
0,30/0,40	6	15	532.041S	G 1810 111 S

STERILE

SYNTHES®  
COLIBRI

BLATTDICKE/ SCHNITTSTÄRKE (mm)	SCHNITT- BREITE (mm)	NUTZBARE LÄNGE (mm)	ARTIKEL-NR. ORIGINAL	ARTIKEL-NR. FEH
0,30/0,40	10	15	532.042S	G 1810 271 S

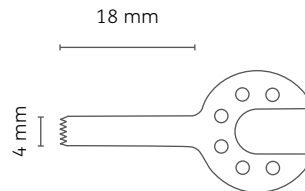
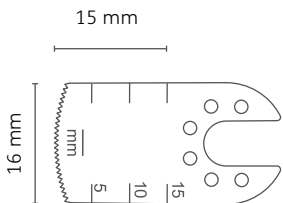

STERILE

SYNTHES®  
COLIBRI

BLATTDICKE/ SCHNITTSTÄRKE (mm)	SCHNITT- BREITE (mm)	NUTZBARE LÄNGE (mm)	ARTIKEL-NR. ORIGINAL	ARTIKEL-NR. FEH
0,30/0,40	16	15	532.043S	G 1810 461 S

STERILE

SYNTHES®  
COLIBRI

BLATTDICKE/ SCHNITTSTÄRKE (mm)	SCHNITT- BREITE (mm)	NUTZBARE LÄNGE (mm)	ARTIKEL-NR. ORIGINAL	ARTIKEL-NR. FEH
0,30/0,40	4	18	532.044S	G 1816 51 S

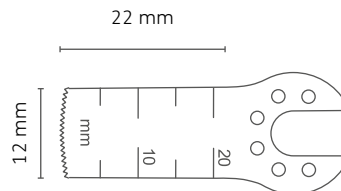
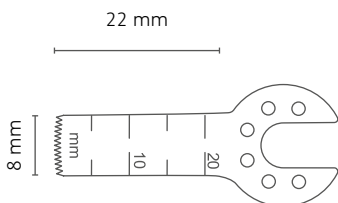

STERILE

SYNTHES®  
COLIBRI

BLATTDICKE/ SCHNITTSTÄRKE (mm)	SCHNITT- BREITE (mm)	NUTZBARE LÄNGE (mm)	ARTIKEL-NR. ORIGINAL	ARTIKEL-NR. FEH
0,30/0,40	8	22	532.045S	G 1824 201 S

STERILE

SYNTHES®  
COLIBRI

BLATTDICKE/ SCHNITTSTÄRKE (mm)	SCHNITT- BREITE (mm)	NUTZBARE LÄNGE (mm)	ARTIKEL-NR. ORIGINAL	ARTIKEL-NR. FEH
0,30/0,40	12	22	532.046S	G 1824 341 S

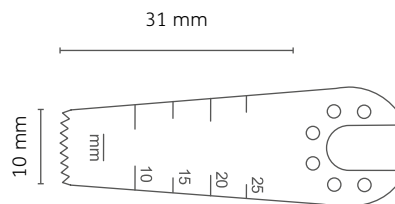
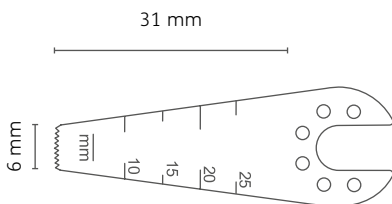

STERILE

SYNTHES®  
COLIBRI

BLATTDICKE/ SCHNITTSTÄRKE (mm)	SCHNITT- BREITE (mm)	NUTZBARE LÄNGE (mm)	ARTIKEL-NR. ORIGINAL	ARTIKEL-NR. FEH
0,30/0,40	6	31	532.047S	G 1844 111 VS

STERILE

SYNTHES®  
COLIBRI

BLATTDICKE/ SCHNITTSTÄRKE (mm)	SCHNITT- BREITE (mm)	NUTZBARE LÄNGE (mm)	ARTIKEL-NR. ORIGINAL	ARTIKEL-NR. FEH
0,30/0,40	10	31	532.048S	G 1844 271 VS



## SYNTHES® COLIBRI

Sägeblätter für oszillierenden Sägeaufsatz

BITTE BEACHTEN SIE UNSEREN BESTELLABLAUF AUF SEITE 3 FÜR DIE UNSTERILEN SÄGEBLÄTTER

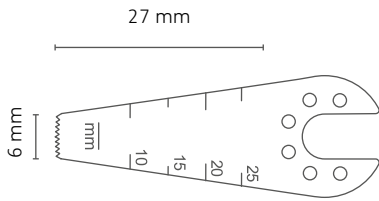

STERILE 				SYNTHES® COLIBRI
BLATTDICKE/ SCHNITTSTÄRKE (mm)	SCHNITT- BREITE (mm)	NUTZBARE LÄNGE (mm)	ARTIKEL-NR. ORIGINAL	ARTIKEL-NR. FEH
0,30/0,60	6	27	532.061S	G 1836 1123 VS

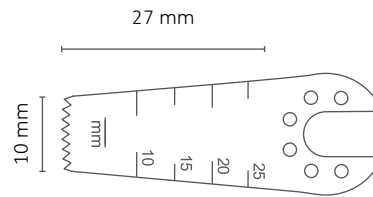

STERILE 				SYNTHES® COLIBRI
BLATTDICKE/ SCHNITTSTÄRKE (mm)	SCHNITT- BREITE (mm)	NUTZBARE LÄNGE (mm)	ARTIKEL-NR. ORIGINAL	ARTIKEL-NR. FEH
0,30/0,60	10	27	532.062S	G 1836 2723 VS

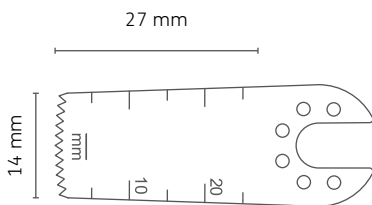

STERILE 				SYNTHES® COLIBRI
BLATTDICKE/ SCHNITTSTÄRKE (mm)	SCHNITT- BREITE (mm)	NUTZBARE LÄNGE (mm)	ARTIKEL-NR. ORIGINAL	ARTIKEL-NR. FEH
0,30/0,60	14	27	532.063S	G 1836 4023 S

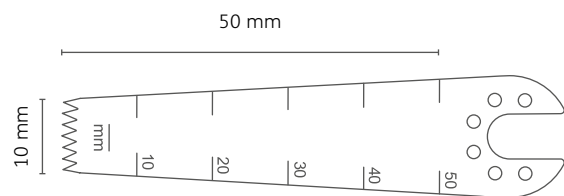

STERILE 				SYNTHES® COLIBRI
BLATTDICKE/ SCHNITTSTÄRKE (mm)	SCHNITT- BREITE (mm)	NUTZBARE LÄNGE (mm)	ARTIKEL-NR. ORIGINAL	ARTIKEL-NR. FEH
0,30/0,60	10	50	532.064S	G 1863 2723 VS

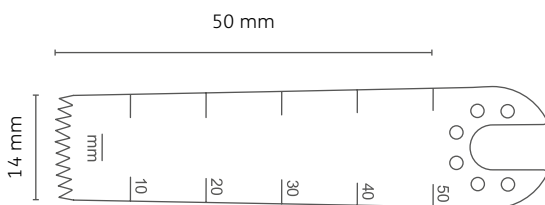

STERILE 				SYNTHES® COLIBRI
BLATTDICKE/ SCHNITTSTÄRKE (mm)	SCHNITT- BREITE (mm)	NUTZBARE LÄNGE (mm)	ARTIKEL-NR. ORIGINAL	ARTIKEL-NR. FEH
0,30/0,60	14	50	532.065S	G 1863 4023 S

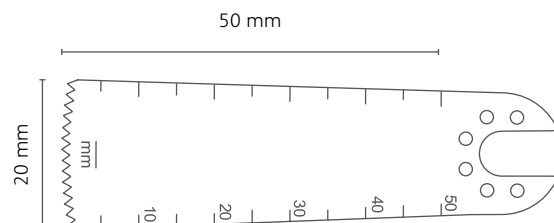

STERILE 				SYNTHES® COLIBRI
BLATTDICKE/ SCHNITTSTÄRKE (mm)	SCHNITT- BREITE (mm)	NUTZBARE LÄNGE (mm)	ARTIKEL-NR. ORIGINAL	ARTIKEL-NR. FEH
0,30/0,60	20	50	532.066S	G 1863 5623 AS

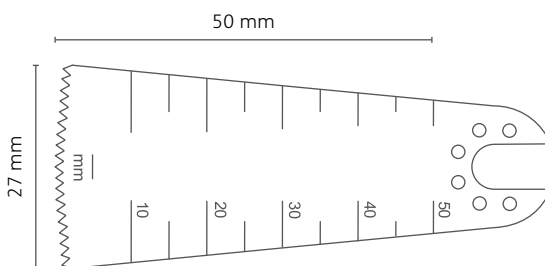



STERILE 				SYNTHES® COLIBRI
BLATTDICKE/ SCHNITTSTÄRKE (mm)	SCHNITT- BREITE (mm)	NUTZBARE LÄNGE (mm)	ARTIKEL-NR. ORIGINAL	ARTIKEL-NR. FEH
0,30/0,60	27	50	532.067S	G 1863 6723 AS

## SYNTHES®

Sägeblätter für Sagittalsägeaufsatz

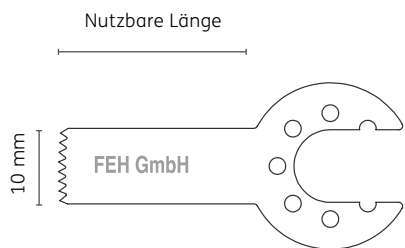
BITTE BEACHTEN SIE UNSEREN BESTELLABLAUF  
AUF SEITE 3 FÜR DIE UNSTERILEN SÄGEBLÄTTER



STERILE 				SYNTHES®
SCHNITT-STÄRKE (mm)	SCHNITT-BREITE (mm)	NUTZBARE LÄNGE (mm)	ARTIKEL-NR. ORIGINAL	ARTIKEL-NR. FEH
0,60	10	25	519.103S	G 1130 2710 S
0,60	10	50	519.104S	G 1163 2710 S

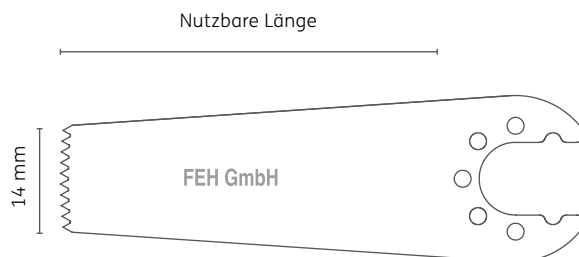

STERILE 				SYNTHES®
SCHNITT-STÄRKE (mm)	SCHNITT-BREITE (mm)	NUTZBARE LÄNGE (mm)	ARTIKEL-NR. ORIGINAL	ARTIKEL-NR. FEH
0,60	14	25	519.250S	G 1130 4010 VS
0,60	14	50	519.150S	G 1163 4010 VS

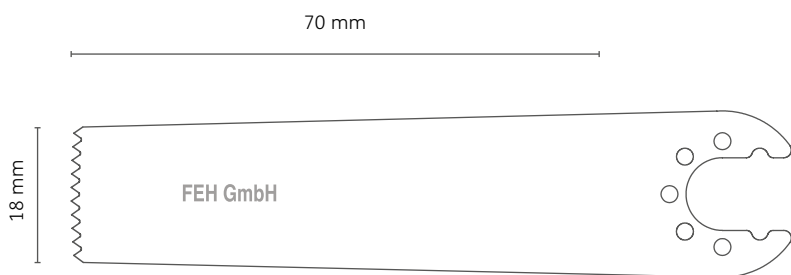

STERILE 				SYNTHES®
SCHNITT-STÄRKE (mm)	SCHNITT-BREITE (mm)	NUTZBARE LÄNGE (mm)	ART.-NR. ORIGINAL	ART.-NR. FEH
1,00	18	70	519.106S	G 1172 5124 VS
1,20	18	70	519.113S	G 1172 5125 VS

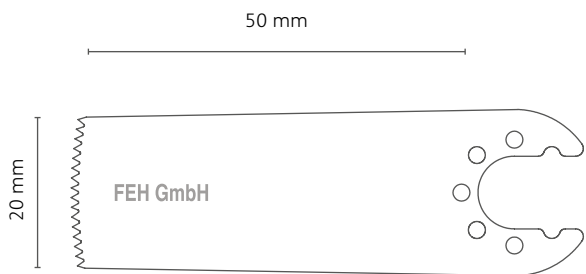
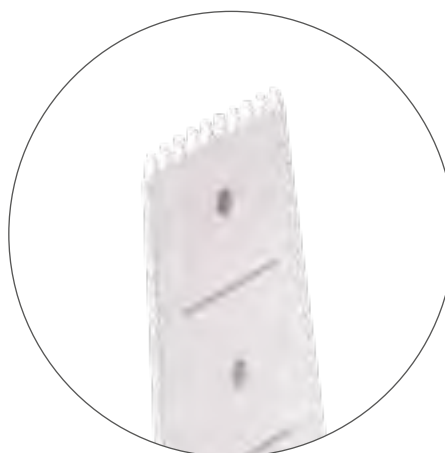

STERILE 				SYNTHES®
SCHNITT-STÄRKE (mm)	SCHNITT-BREITE (mm)	NUTZBARE LÄNGE (mm)	ARTIKEL-NR. ORIGINAL	ARTIKEL-NR. FEH
0,60	20	50	519.105S	G 1163 5610 VS

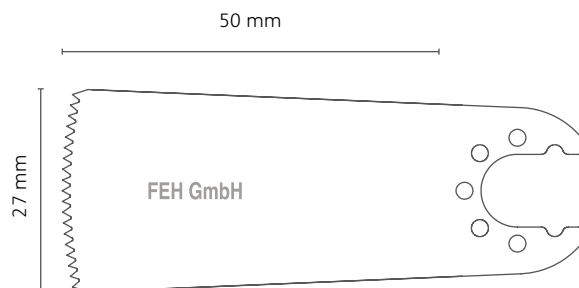

STERILE 				SYNTHES®
SCHNITT-STÄRKE (mm)	SCHNITT-BREITE (mm)	NUTZBARE LÄNGE (mm)	ARTIKEL-NR. ORIGINAL	ARTIKEL-NR. FEH
0,60	27	50	519.100S	G 1163 6710 AS



## AESCALAP® ACCULAN®

Sägeblätter für Sagittalsägeaufsatz

BITTE BEACHTEN SIE UNSEREN BESTELLABLAUF AUF SEITE 3 FÜR DIE UNSTERILEN SÄGEBLÄTTER

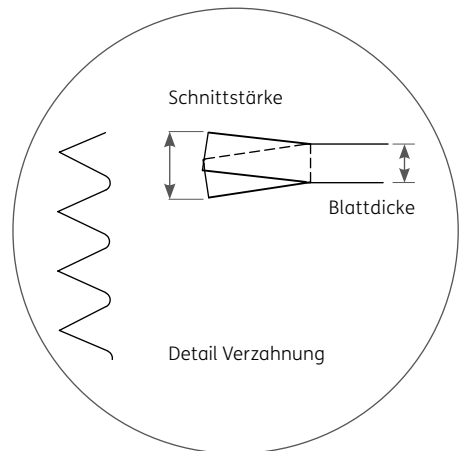
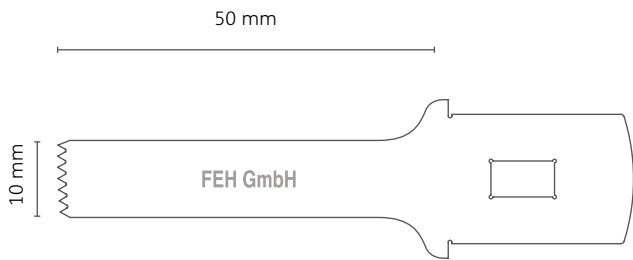

STERILE 

AESCALAP®  
ACCULAN®

BLATTDICKE/ SCHNITTSTÄRKE (mm)	SCHNITT- BREITE (mm)	NUTZBARE LÄNGE (mm)	ARTIKEL-NR. ORIGINAL	ARTIKEL-NR. FEH
0,5/0,8	10	50	GC215R	G 1263 279 S

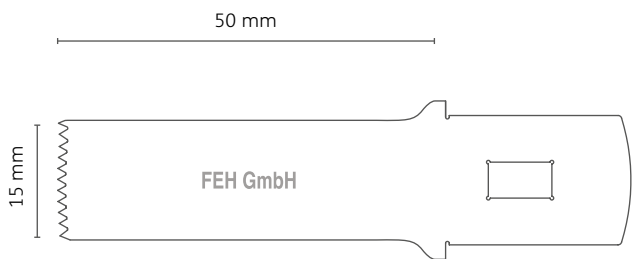

STERILE 

AESCALAP®  
ACCULAN®

BLATTDICKE/ SCHNITTSTÄRKE (mm)	SCHNITT- BREITE (mm)	NUTZBARE LÄNGE (mm)	ARTIKEL-NR. ORIGINAL	ARTIKEL-NR. FEH
0,5/0,8	15	50	GC216R	G 1263 439 S

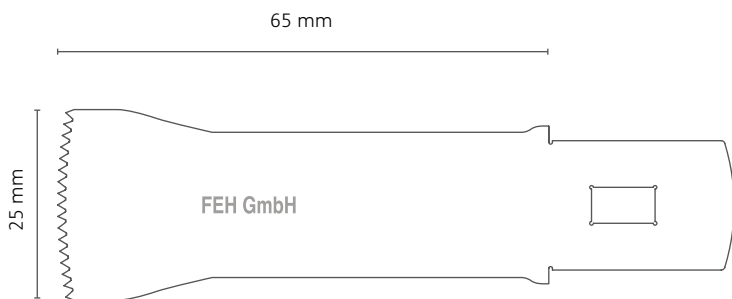

STERILE 

AESCALAP®  
ACCULAN®

SCHNITTSTÄRKE (mm)	SCHNITT- BREITE (mm)	NUTZBARE LÄNGE (mm)	ARTIKEL-NR. ORIGINAL	ARTIKEL-NR. FEH
0,90	25	65	GE253R	G 1271 6418 AS

Synthes ist die Handelsmarke von Synthes.  
 Aesculap ist die Handelsmarke der B. Braun Melsungen AG.  
 Aesculap Acculan ist die Handelsm. der B. Braun Melsungen AG.  
 Stryker ist die Handelsmarke der Stryker Corporation.  
 Hall ist die Handelsmarke der ConMed Corporation.  
 Linvatec ist die Handelsmarke der ConMed Corporation.  
 3M ist die Handelsmarke der ConMed Corporation.  
 De Soutter ist die Handelsmarke von De Soutter.

**FEH GmbH ist nicht affiliert mit diesen Firmen.**

 **Made in Germany**  
 als Garant für Qualität.

Bei der Produktion setzen wir auf den Standort Deutschland.

Zertifiziert sind wir nach MPG, DIN EN ISO 13485: 2016  
 Unsere Sägeblätter tragen die Kennung des TÜV Nord CE0044.





# BESTELL- & ANGEBOTSFORMULAR



## FEH Medizintechnik

MEDIZINTECHNISCHE PRODUKTE

**FEH GmbH**  
Am Stadtwalde 15  
48432 Rheine

T: +49 (0) 59 71 - 98 56 63  
F: +49 (0) 59 71 - 8 70 00

E: [Zentrale@FEH-Med.com](mailto:Zentrale@FEH-Med.com)  
W: [www.FEH-Med.com](http://www.FEH-Med.com)

Firma/Krankenhaus
Kd. Nr.
Ansprechpartner
Anschrift
Plz  Ort.
Fon
Fax
E-Mail

## SÄGEBLÄTTER

TYP SÄGEBLATT	ARTIKEL-NR. ORIGINAL	ARTIKEL-NR. FEH	MENGE

Bestellung    Anfrage

**JETZT BESTELLEN**

**FAX:** Bitte das obenstehende Formular vollständig ausfüllen und **per Fax zurücksenden an +49 (0) 59 71- 87 00 0**

**POST:** Schicken Sie Ihre Bestellung in einem Kuvert an:  
**FEH GmbH, Am Stadtwalde 15, 48432 Rheine**

**MAIL:** Bestellung einscannen und an [zentrale@feh-med.com](mailto:zentrale@feh-med.com) senden oder digitales Bestellformular von [www.feh-med.com](http://www.feh-med.com) verwenden

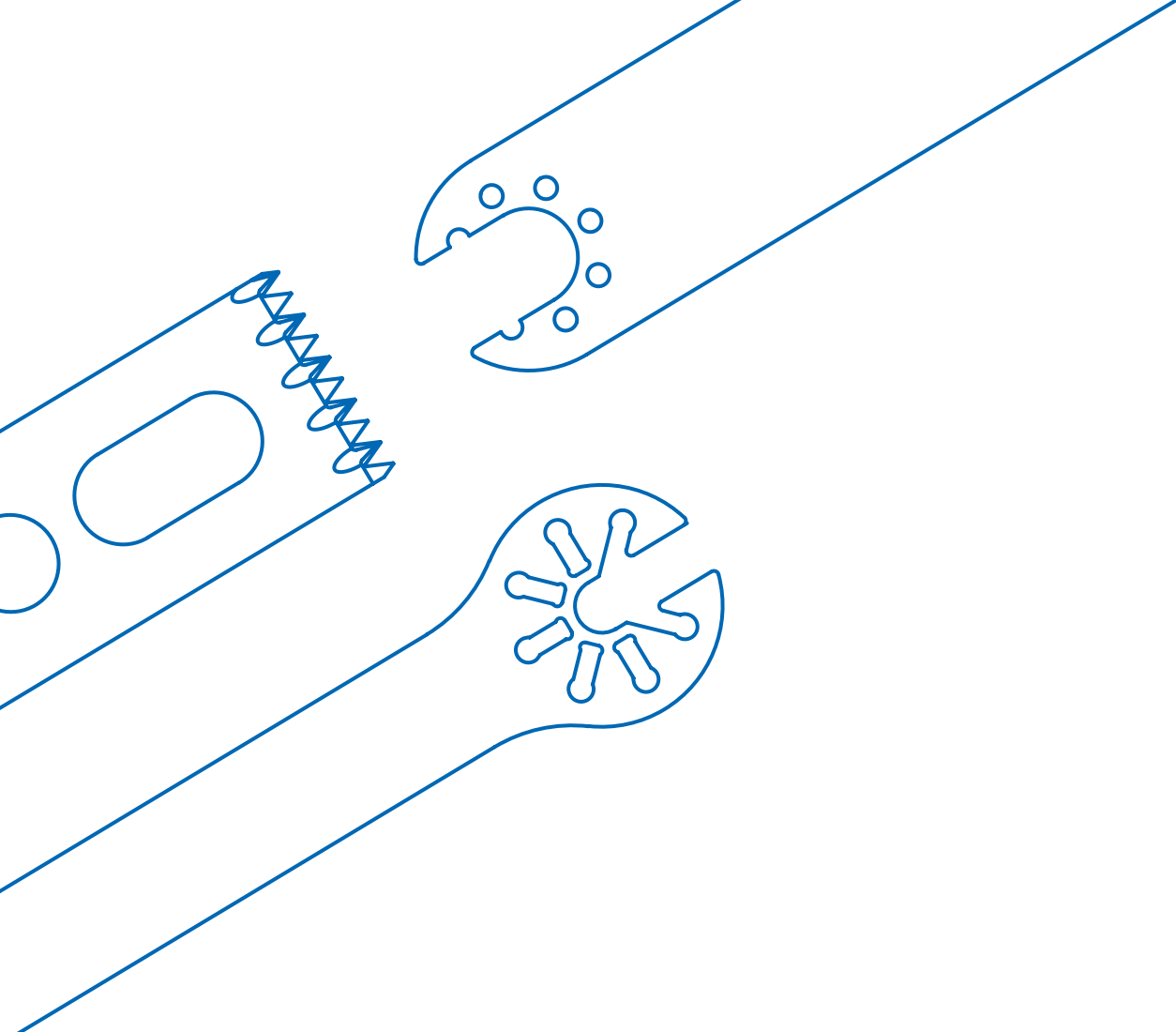

## **WIR HABEN LÖSUNGEN FÜR JEDES ANWENDUNGSPROBLEM!**

Durch die hohe Qualität und Präzision der anwenderorientierten Produkte kann ein optimales Operationsergebnis erreicht werden.

Sprechen Sie uns an, wir haben für Sie die adäquate Lösung.  
Qualität, Kosteneffizienz und Kundenservice sind die Eckpfeiler  
unseres unternehmerischen Handelns.

**FEH GmbH**  
Medizintechnische Produkte

Am Stadtwalde 15  
48432 Rheine, Germany

Tel: +49 (0) 59 71 - 98 56 63  
Fax: +49 (0) 59 71 - 8 70 00  
Zentrale@FEH-Med.com  
www.FEH-Med.com